

WASATCH COMMUNITY GARDENS

Wow! Plants Are So Cool!

Part 2 – Kindergarten

Laura Judd and Mary Jo Neal Tedesco

2011

Table of Contents

Introduction	4
Plant Basics - September	5
1. Growing In The Garden	5
2. Help Me Out!	14
3. Do We Eat Plants?	21
4. It's Not Dirt, It's Soil!	27
Garden Discoveries - October	33
5. Creepy Crawlies!	33
6. Six of One,	50
7. Plants Are Friends Too!	55
8. A Pumpkin Is a What?	60
Changes - November	68
9. It's Chilly Out Here!	68
10. The Worms Crawl In-	75
11. Plant Use Detectives!	83
12. The Botanists' Hike	98
Plant Parts - December	104
13. We All Work Together!	104
14. More Plant Part Jobs!	109
Indoor Plant Experiments - January	121
15. Let's Build Our Plant Lab!	121
16. Really, That's What We Need!	130
17. Yikes! It's Hot In Here	134
18. Plants From Parts?	138

<i>Garden Treasures - February</i>	142
19. From Garden to Tummy	142
20. Let's Go Shopping!	149
21. Now It's Really Cold!	153
22. Wow! You Know A Lot	159
<i>Colors of the Garden - March</i>	164
23. Flower Power!	164
24. Eat a Rainbow	170
25. Planting a Cool Rainbow	181
26. Poetry in the Garden	185
<i>Spring Fun - April</i>	188
27. Signs of Spring	188
28. Pound That Plant!	193
29. Let's Make Some Connections!	197
<i>Fruits of Our Labor - May</i>	201
30. Thank You, Pollinators!	201
31. Hands Across the Garden	219
32. Aha! We Found It!	224
33. Let's Eat!	229
<i>Curriculum Connections</i>	232
<i>Resources</i>	235

Introduction

Wow! Plants Are So Cool! (Part 2) is unique in that it is written and arranged specifically for the teachers of the Salt Lake valley. It compliments Part 1 so that, together, a teacher has two full school years of gardening curriculum to alternate between as well as many choices of indoor or outdoor lessons. Each lesson is also written in a way that anyone can teach it, even those who have never gardened before! Wow! Plants Are So Cool! (Part 2) is local, relevant, and accessible.

Local: The curriculum meshes the traditional 9-month school year with seasonal gardening activities. Gardening in the winter? Absolutely! Students can grow plants indoors as well as conduct a wide variety of plant experiments and explorations. At the beginning of each lesson, there is a picture of a sun, students enthusiastically raising their hands at desks, or both. These pictures indicate whether the lesson is intended to be outdoors or indoors. There is a lesson for every week of the school year.

There are also local resources throughout the curriculum. For example, need free seeds? Go to Western Garden Center 550 South 600 East, Salt Lake City UT 84102, 801.364.7871. Contact a manager towards the end of November. They will give teachers the left over seeds from that year!

Relevant: Every student eats food. Plants are a part of their daily lives and their existence depends on them. Gardening is relevant in that it shows students how plants grow and where their food comes from. However, some teachers point out they already have more things to teach in a day than they can fit in. How could it be possible to add *one more thing*? The answer to that is easy. Don't! Instead of thinking of the garden as an added chore, think of it as a fun, engaging way to teach students the skills they are already supposed to be learning. There is an objective box at the beginning of each lesson. It states the main goal of the lesson and has bullet points explaining the skills on which the students will be working. Many of those bulleted points are taken directly from the Salt Lake City School District Curriculum Standards 2011. As science is at the center of all of the lessons, we have included a supplementary table that charts the exact science standards that each lesson meets. Every lesson is relevant to the students' learning!

Accessible: We received feedback, when we were going into classrooms to teach our lessons, that some teachers would not teach gardening if we weren't coming in to teach it for them. Some teachers did not consider themselves avid gardeners and some had never gardened at all. To address this, we have included background information in pictures, diagrams, charts, text, and even dialogue within each lesson. Of course, lessons do not need to be read aloud word for word. Go with your own comfort level, taking from the lessons what you need.

Wow! Plants Are So Cool! (Part 2) is local, relevant, and accessible. Teaching these lessons will engage your students in a hands-on way of learning the skills they are asked to master. Have fun and keep growing!

1. Growing In The Garden

Objective: Introduce students to the garden program

- Learn why plants are important
- Practice observation skills
- Evaluate what students already know about plants and gardening
- Introduce the Garden Club, Garden Names, Garden Rules, and the Discovery Journal

Materials

- Poster board for Garden Rules poster (see attached list of rules)
- Pre-garden program quizzes (attached)
- Garden Name badges and suggestions (attached)
- Clip on name tag holders
- Discovery Journal covers (attached)
- Binders for journals
- Outdoor gardening bed
- Garbage bag if the garden bed needs weeding

**Preparation**

- Make Garden Rules poster (indoor rules on one side, outdoor on the other)
- Make copies of quizzes, journal covers, and blank Garden Name badges
- Purchase journal binders, name tag holders

Procedure

Today we are starting our Garden Program. You are going to have lots of plant fun outside in the garden and inside in our plant lab too.

Introduce the Garden Club.

- As members they will become botanists by spending time outdoors discovering how plants live and by growing plants in their garden. They will also grow plants and do experiments in the classroom.
- They will have special garden names and nametags. Choose the garden names and fill out the nametags during the week (see attached suggestions).
- They will each have a “Discovery Journal” in which to keep papers, such as observations, questions, and weekly worksheets, related to the garden program. They can decorate the covers during the week and glue them onto the binder front.

Evaluate: Before we go outside to explore our garden, I'd like to find out what you know about plants and gardens already.

- Have the students fill out the pre-garden program plant knowledge quiz. The purpose of this is to discover what knowledge the students have about plants at this point. They will take a post quiz at the end of the year.
- After they finish the quiz, take a few minutes to let the student tell you about some of the things that they know about plants.

Explore! It's time to go outside to the garden.

- Take along the Garden Rules poster.
- Have the students sit or stand in an orderly circle and go over the outdoor Garden Rules. It is important that they understand that the outdoor area is also a classroom and that they must follow the rules in order to have the privilege of working outside.
- Go over the inside garden rules before the next week's activities.

Question: You have told me some things that you know about plants, but do you really think that plants are all that important to us?

- Take several answers using prompts if needed. Point out that they are all wearing a plant and let them guess what it is (cotton).
- Have the students close their eyes and use their imaginations to picture a world with no plants. There would be no grass, bushes, trees, or flowers.
 - Give them a few minutes to imagine.
 - Have them open their eyes and describe the world that they saw.

Question: Did you like that world? Do you think that you could survive there? Was there anything to eat or any shelter? Was anything alive there? Look around now and see if you like this world better!

Discover the Garden!

- Have the students gather around the garden area.
- Spend some time looking at the garden bed, feeling and smelling the soil and observing the plants that are already growing if there are any.
- What does the soil feel like?
- What does it smell like?
- Is it wet or dry?
- Is there anything in it besides "dirt"?
- Does it look like a good place for plants to grow?
- If the gardening area is full of weeds, use the following procedure.

Question: Do these look like plants that are good to eat? Do you think that new plants would have enough room to grow here? What can we do to fix this? Make sure to identify the plants that should stay in the garden bed if there are vegetables already growing.

- Demonstrate how to pull weeds out by holding the plant close to the soil line, wiggling it back and forth several times, and pulling the plant out ("Wiggle, wiggle, pull!").
- Point out the roots and let them know to try and get the roots out each time they pull out a plant so that the plant will not grow back into their newly cleaned growing space.

- Have the students pull up as many weeds as they can and put them in 3-4 designated piles.
- Take the time to let the children really observe the plants that they are pulling out. Note how they feel, smell, and look.
- Put all of the weeds in the garbage bags or compost pile if you have one.

Let the students know that next week they will learn how to plant and take care of garden plants. They will plant lettuce and radishes for a fall harvest.

Let's Review

- *What do you like about plants?*
- *Describe how the soil feels and smells.*

Keep Exploring

- Look up pictures of radishes and lettuce so that they will know what they are going to plant next week.

1. I Know A lot About Plants!- K

Name _____ Date _____

Draw and color a plant with all of its parts:

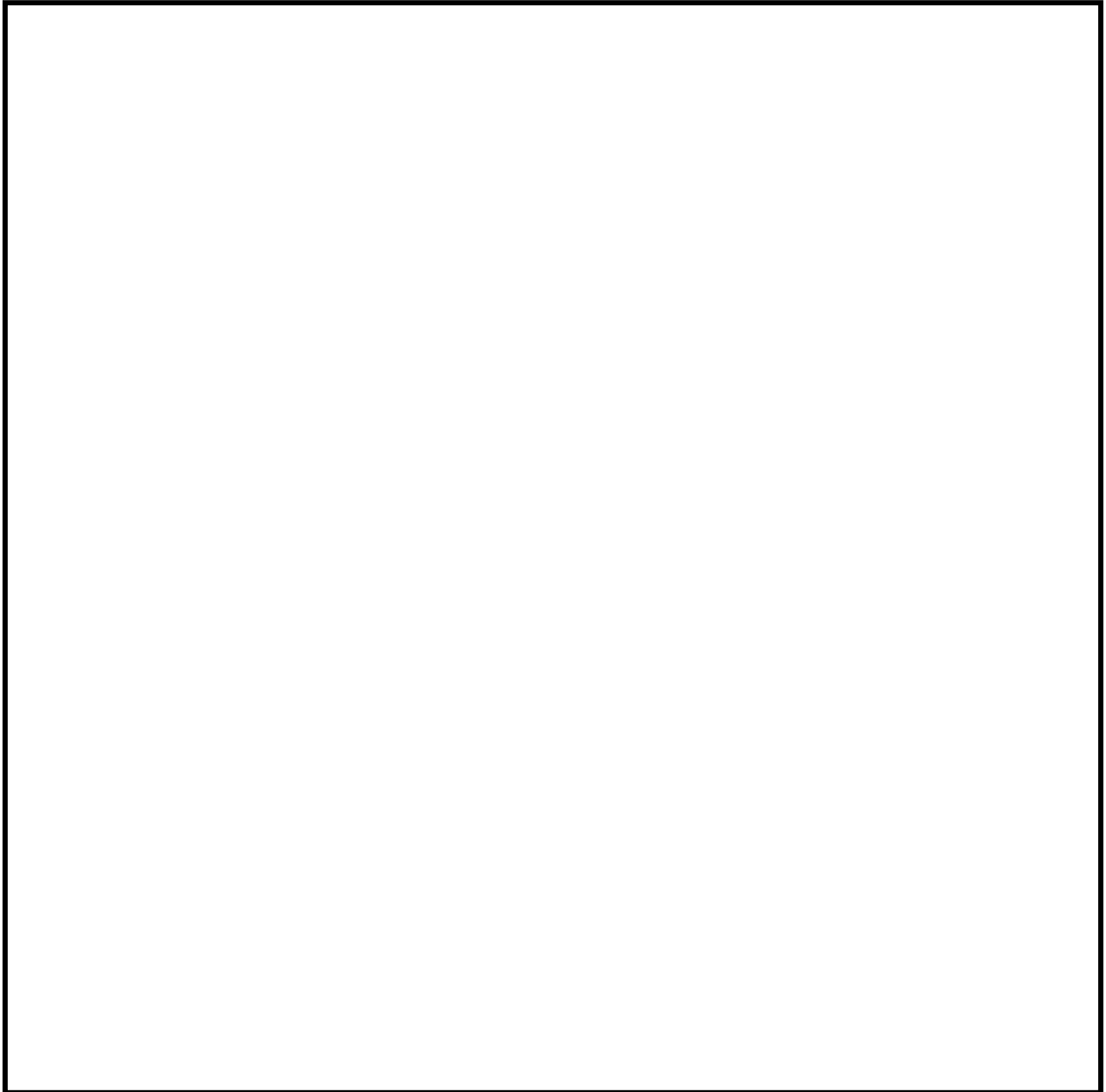

Do you eat plants? _____

Choosing a Garden Name

A *Garden Name* is the student's first name plus the name of something in the garden (plant, insect, animal) that starts with the first letter of the student's name. Some examples are "Jonathan Jack O' Lantern, Dana Daisy, and Thomas Tomato". If a student needs help, have the rest of the group lend a hand. Here are some suggestions:

- A** Apple, Arugula, Asparagus, Artichoke, Acorn, Allium, Avocado, Almond
- B** Basil, Broccoli, Beet, Brussel Sprout, Bean, Begonia, Blueberry, Bok Choy, Banana, Bee, Butterfly, Bell Pepper, Beetle, Bird
- C** Cucumber, Cauliflower, Corn, Cilantro, Chard, Carrot, Celery, Cherry, Citrus, Chives, Coriander, Cumin, Carnation, Caterpillar, Cayenne Pepper, Cinnamon, Compost
- D** Dill, Date, Dandelion, Delicata Squash, Daisy, Dragonfly, Dig
- E** Eggplant, Echinacea, Elderberry, Endive, Escarole, Eucalyptus, Earthworm
- F** Fig, Fennel, French Sorrel, Fern, Ficus, Filbert, Forsythia, Fava Beans
- G** Garlic, Grape, Guava, Gooseberry, Gourd, Grains, Ginger, Grasshopper, Garden
- H** Horseradish, Hosta, Honeydew Melon, Hibiscus, Hydrangea, Hyacinth, Hummingbird
- I** Ivy, Iris, Impatiens, Ice Plant, Icicle Radish, Iceberg Lettuce
- J** Jalapeño, Jicama, Jack O' Lantern, Jerusalem Artichoke, Juniper, Jumping Bean, Jasmine
- K** Kale, Kiwi, Kumquat, Kohlrabi, Kniphofia, Katydid
- L** Lettuce, Leek, Lemon balm, Lemon, Lavender, Lily, Lupine, Lobelia, Lychee, Lime, Ladybug, Lemongrass
- M** Morning Glory, Mint, Mushroom, Melon, Mango, Macadamia Nut, Marigold, Maple, Maple Leaf, Magnolia, Mallow, Mustard, Mizuna
- N** Nasturtium, Nectarine, Nut, Napa Cabbage, Nandina, Nerine Lily
- O** Onion, Oregano, Okra, Oak, Orange, Oxalis

P Pumpkin, Pea, Parsnip, Potato, Pepper, Parsley, Plum, Poppy, Phlox, Pecan, Peanut

Q Quince, Quinoa, Quercus, Queen Anns's Lace

R Radish, Rutabaga, Rosemary, Raspberry, Rhubarb, Radicchio

S Spinach, Squash, Sage, Strawberry, Savory, Sweet Pepper, Sunflower, Swiss Chard, Sweet Potato, Spider

T Tomato, Turnip, Tomatillo, Thyme, Tulip, Tarragon, Turmeric, Tree

U Ulmus Elm, Ugni Evergreen, Umbrella Pine

V Violet, Vinca, Verbena, Vine, Viola, Veronica

W Watermelon, Wallflower, Wheatgrass, Wisteria, Woolly Thyme, Walnut, Wildflower, Willow, Wasp, Watercress

X Xeric, xylem, Xeriscaping

Y Yarrow, Yucca, Yew, Yam

Z Zebra Plant, Zoysia Grass, Zucchini, Zelkova, Zinnia, Zipper Iris

My Discovery Journal

NAME _____

Garden Rules

Outdoor Rules:

1. Respect yourself, those around you, and the garden.
2. Eat and pick only what you are invited to eat and pick.
3. Keep your feet on the pathways.
4. Do not kill or harm any bugs, insects, or animals in the garden.
5. Trash, recycling, and food scraps go in their own homes.



Indoor Rules:

1. Respect yourself, those around you, and the garden activities.
2. Stay in the circle or group.
3. Sit on your pockets.
4. Be involved 100% in each activity.
5. Use a quietly raised hand, and wait until you are called on before answering a question.
6. One person speaks at a time during group discussions.

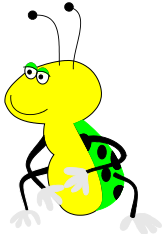
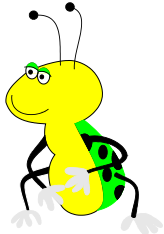
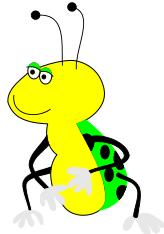
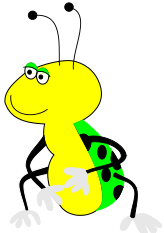
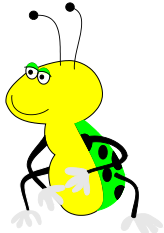
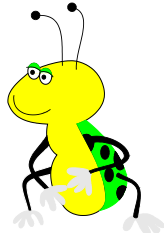
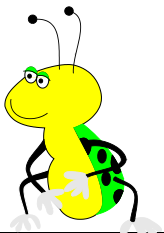
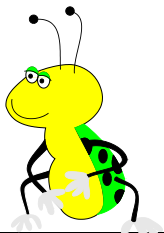
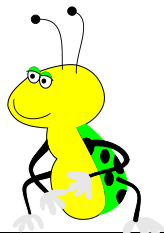

<div data-bbox="151 191 586 480" style="border: 1px solid black; height: 138px;"></div> <div data-bbox="172 548 370 716" style="border: 1px solid black; padding: 5px;">Garden Club Member</div> <div data-bbox="412 499 574 730"></div>	<div data-bbox="630 191 1065 480" style="border: 1px solid black; height: 138px;"></div> <div data-bbox="651 548 849 716" style="border: 1px solid black; padding: 5px;">Garden Club Member</div> <div data-bbox="888 499 1050 730"></div>	<div data-bbox="1109 191 1544 480" style="border: 1px solid black; height: 138px;"></div> <div data-bbox="1130 548 1328 716" style="border: 1px solid black; padding: 5px;">Garden Club Member</div> <div data-bbox="1364 499 1526 730"></div>
<div data-bbox="151 764 586 1054" style="border: 1px solid black; height: 138px;"></div> <div data-bbox="172 1121 370 1289" style="border: 1px solid black; padding: 5px;">Garden Club Member</div> <div data-bbox="412 1073 574 1304"></div>	<div data-bbox="630 764 1065 1054" style="border: 1px solid black; height: 138px;"></div> <div data-bbox="651 1121 849 1289" style="border: 1px solid black; padding: 5px;">Garden Club Member</div> <div data-bbox="888 1073 1050 1304"></div>	<div data-bbox="1109 764 1544 1054" style="border: 1px solid black; height: 138px;"></div> <div data-bbox="1130 1121 1328 1289" style="border: 1px solid black; padding: 5px;">Garden Club Member</div> <div data-bbox="1364 1073 1526 1304"></div>
<div data-bbox="151 1333 586 1623" style="border: 1px solid black; height: 138px;"></div> <div data-bbox="172 1690 370 1858" style="border: 1px solid black; padding: 5px;">Garden Club Member</div> <div data-bbox="412 1642 574 1873"></div>	<div data-bbox="630 1333 1065 1623" style="border: 1px solid black; height: 138px;"></div> <div data-bbox="651 1690 849 1858" style="border: 1px solid black; padding: 5px;">Garden Club Member</div> <div data-bbox="888 1642 1050 1873"></div>	<div data-bbox="1109 1333 1544 1623" style="border: 1px solid black; height: 138px;"></div> <div data-bbox="1130 1690 1328 1858" style="border: 1px solid black; padding: 5px;">Garden Club Member</div> <div data-bbox="1364 1642 1526 1873"></div>

2. Help Me Out! What Plants Need to Grow

Objective: Learn what necessities plants need to grow well.

- Learn how to correctly plant seeds.
- Learn to take responsibility for plants in the garden.
- Learn to cooperate and share garden tasks.
- Make predictions.
- Observe seed germination

Materials

- Kale, spinach, lettuce, and radish seeds for planting outside.
- Some other seed varieties for observing if available
- Watering can
- Trowel if needed for smoothing soil
- 4 clear 20 oz. plastic cups
- 4-5 small plastic bowls or zip lock bags
- Question Book cover
- Binder and binder paper for Question Book
- Planting chart (attached)
- Pictures of radishes, spinach, kale, and lettuce (attached)
- Clear plastic box (at least 4"x4")
- Small bag of potting soil
- Ruler
- Plant markers for identification
- Garden name badges to wear for this Garden Club activity (use for all future activities)



Preparation

- Look at your outside garden bed and decide where you will plant each type of seed. Look at the attached chart for spacing information.
- Decide if a trowel will be needed to smooth out soil.
- Fill the plastic cups with soil up to about ½ " from the top
- Print out the Question Book cover and attach to the binder.
- Put observation seeds in bowls or zip lock bags (one type of seed in each)
- Print out planting chart and vegetable pictures
- Gather materials to take outside (trowels, watering can, seeds, ruler, clipboards, and pencils)

Procedure

Introduce the Question Book by first asking if anyone has some questions about plants. Prompt them with a few of your own if they do not respond.

- When someone asks a question, show them the book, explaining that each time they have a question about plants, the garden, or their experiments, you will write it down for them.
- Go over the questions regularly for the students to try to answer.
- Spend some time in class figuring out answers (discussions, research, etc.).
- Always encourage questions!

Observation: Have the students sit in a circle and pass around the bowls with seeds. Prompt the students to look at and touch very carefully each type of seed to discover the differences and similarities between them. Spend a few minutes getting feedback on their observations.

We are going outside to plant some seeds today. First we need to figure out what things plants need to grow well.

Question: Can someone tell me about what plants need to grow?

- Take several answers, prompting until the correct answers come up: sunlight, air, nutrients (like vitamins from the soil), space to grow, warmth, water

Now that the students have some knowledge about plant needs, it's time to go out to the garden to plant seeds for a fall crop. The plants will not get very large before winter really sets in, but they can see the growth that there is, and eat some small radishes and leaves. The spinach and kale can overwinter with protection (see Lesson #9) and will grow again in the spring for an early harvest.

Explain how to plant seeds.

- First demonstrate with a drawing on the board. Show that seeds need to be planted at a certain depth and a certain distance from one another.
- There are six jobs when planting: smoothing out the soil (use a trowel here if needed), measuring depth and distance, making a hole, dropping in the seed, covering the seed and watering.
- Show that they can use their hands to measure in the garden by measuring their fingers with a ruler. For example, the right depth to plant a spinach seed could be up to the first knuckle on their index finger or about three times the diameter of the seed.
- Then demonstrate the planting steps using the cups with soil and plant four of one type of seed, at the correct depth (see attached chart), in each cup. Spread the seeds out next to the sides of the cup so that the students will be able to see the seeds sprout and grow in the classroom.
- Put the seed cups in a warm area of the room and keep the soil moist, but not soggy. When they sprout, move them to a light area for observation.

Question: What do you think that the seeds in these cups will grow? We'll keep an eye on them over the next few weeks.

Let's go outside to plant seeds in our garden and to think of a garden name for our space. Bring the seeds and watering can. Have the students stand in a circle around the garden bed.

Question: Let's review again what things plants need to survive. Does this area look as if it can provide those things?

- Review the needs (water, air, nutrients, sunlight, space) and observe the garden area's potential to fulfill those needs.

Divide the class into four groups, one for each type of seed.

- Plant one type of seed at a time in the areas that you chose earlier.
- Demonstrate the planting procedure for each type of seed.
- Divide the six jobs needed for planting among the students in that group.
- Be sure to measure depth and spacing. The hand method will probably work most easily.
- Supervise one group at a time as they come up and plant their seeds.
- The students in the waiting groups will discuss possible names for their garden. You can write them down when you get back to class. The students can vote on a final name during the week and make a sign to put on the garden bed.
- Mark each area planted with plant markers that include the plant name and the date.

Question: Can these seeds grow without help from us? What do we need to do regularly to help our plant? (water, keep out weeds that would take up space)

Let's Review

- *What type of seeds did we plant?*
- *How can we take care of our new seeds in the garden?*
- *What do you think will happen to the seeds in the seed cups?*

Keep Exploring

- Read one or more of these books:
 - The Tiny Seed by Eric Carle
 - The Carrot Seed by Ruth Krauss
 - Fran's Flower by Lisa Bruce

2. Help Me Out!-K

Name _____ Date _____

Circle the things that plants need to grow:

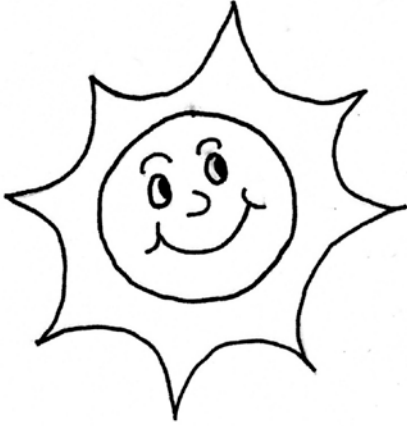

SUN

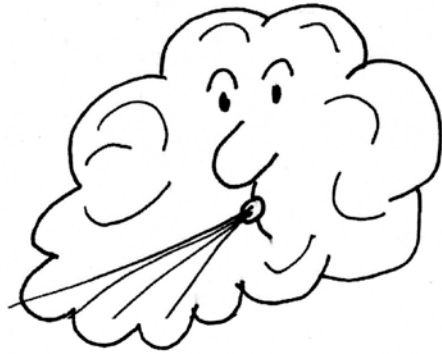

AIR

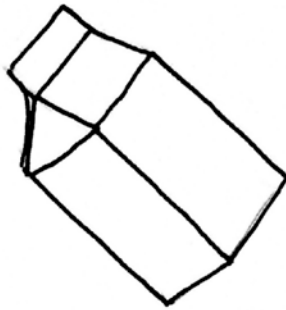

MILK



WATER



KETCHUP

THE QUESTION BOOK

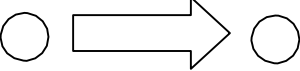
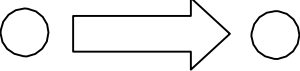
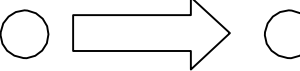
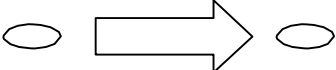

Plant	Seed Spacing*	Planting Depth**
Spinach	<p style="text-align: center;">1-2 in.</p>  <p style="text-align: center;">Thin to about 4-8" apart when plants are about 2" tall.</p>	1/4-1/2 in.
Kale	<p style="text-align: center;">2 in.</p>  <p style="text-align: center;">Thin to 12-15" apart when plants are about 2" tall.</p>	1/4-1/2 in.
Radishes	<p style="text-align: center;">1/2-1 in.</p>  <p style="text-align: center;">Thin to 4" apart when plants are about 1" tall.</p>	1/2-1 in.
Lettuce	<p style="text-align: center;">1/8-1/4 in.</p>  <p style="text-align: center;">Thin to 8-12" apart when plants are about 2" tall.</p>	1/8-3/4 in.

*Note: Plants can be closer together when the soil is healthy and rich in nutrients. Put them further apart if the soil is poor.

**Note: Plant seeds the more shallow depth in cool soils.

Vegetables In Our Garden

Lettuce



Kale



Spinach



Radishes



3. Do We Eat Plants? Salsa Party!

Objective: Learn the names of the basic plant parts.

- Learn that plants have parts just as people do.
- Discover that people eat many plant parts
- Practice observation skills
- Make salsa out of several plant parts

Materials

- List of plant parts that we eat (attached)
- One real example of each plant part. Some suggestions:
 - Root: carrot, beet, radish, jicama, yam (no potatoes-they are stems)
 - Stem: asparagus, broccoli (stem part)
 - Leaf: lettuce, cabbage, spinach
 - Flower: broccoli, cauliflower, edible flowers such as nasturtiums
 - Seed: dried beans, sunflower seeds, nuts
 - Fruit: apple, tomato, green bean, zucchini, orange, raisins
- *Note: There will be confusion about fruits and vegetables. In botanical terms, any part of the plant that contains seeds is a fruit. So even edibles such as tomatoes and squash are fruits. The word vegetable is a culinary term used in the common vernacular to distinguish savory from sweet plant parts. The students will be learning the correct botanical terms and will learn more about fruits in a future lesson.
- For salsa:
 - 6 large tomatoes
 - Bunch of cilantro
 - 3 jalapeno peppers (optional!)
 - 1 lime
 - Bunch of green onions
 - Salt
 - Large bag of chips
 - 6 medium bowls for salsa and 6 more for chips
 - 1 large bowl for mixing
 - 1 container for water in which to rinse plants
 - Mixing spoon
 - Paper or cloth towels
 - 1-2 cutting boards
 - 1-2 knives for cutting
- Portable white board or large paper with a drawn plant outline (see attached)
- Markers



Preparation

- Draw plant part diagram on a portable white board or large piece of paper.
- Put the sample plant parts into six bags with a different plant part in each.
- Fill water container for rinsing plants outside.
- Arrange all materials to take outside.
- Go outside and choose some different types of plants that the students will observe during the class (see below).

Procedure

Take the class out to the garden area. Bring all lesson materials.

Question: Has anything changed in the garden bed or around the bed in the schoolyard area since last week?

- Spend a few minutes making and reporting on observations.

Observation: Have three students, who look somewhat different, stand up together. Ask the rest of the class to point out differences in height, hair color, eye color, etc.

Question: Everyone here looks different, but do they all have body parts such as two arms, eyes, ears, legs, one nose, etc?

Observation: Walk to a few different plants in the garden and schoolyard. . Have them use their eyes and then gently touch the plants with their fingers. Have students describe some similarities and differences between the plants.

Question: These plants look different, just as we look different, but do they all have similar parts too?

- Show the drawn plant diagram.
- Ask for ideas about the names of the parts of the plant starting with the roots.
- Take answers until the students name all six main plant parts (roots, stems, leaves, flowers, fruits, and seeds).
- Write the names next to the plant parts on the picture.
- Inform the students that they will be learning more about all of these plant parts over the next few weeks and do some fun scientific experiments along the way.

Question: Do you eat plant parts? (Yes!)

- Take answers to this question. You can refer to suggestions on the attached edible plant list.
- Divide the students into five groups and give each group a bag with a plant part.
- Give them a few minutes to figure out what plant part they have.
- Have each group give their report with other students helping to figure out any mystery plant parts.

Let's make something yummy out of several plant parts. How about some salsa?

- Show each component of the salsa and see if they can guess what plant part it is.
- Divide up the class so that there is a group for each of the rinsing, chopping, and stirring jobs of the salsa making. Demonstrate safe knife cutting skills for the cutting group and oversee this activity.
- Have the last group divide the large bowl of salsa into the smaller bowls.
- Pass out bowls of chips and enjoy a medley of plant parts!

Let's Review

- Put the plant diagram back up, erase or cover the plant part names, and ask the students to name the parts again.
- *What is your favorite fruit or vegetable to eat? What part of the plant is it?*

Keep Exploring

Explore the garden and schoolyard identifying plant parts along the way.

- Divide the class into as many groups as there are adults.
- Each group goes in a different direction looking for plant parts.
- Spend time looking for all parts, especially the harder to find ones such as visible roots and small seeds.
- Remind the students to look up and down as well as straight ahead.







Look at the school menu for the week.

- Note the vegetable or vegetables to be served each day.
- Make a list of the plant parts and put each vegetable to be served in the correct category.
- Are some parts left out?

3. Do We Eat Plants?-K

Name _____ Date _____

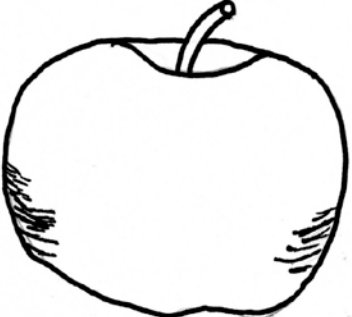
Color the plant parts.

<p>Root</p> 	<p>Stem</p> 
<p>Leaf</p> 	<p>Flower</p> 
<p>Fruit</p> 	<p>Seed</p> 

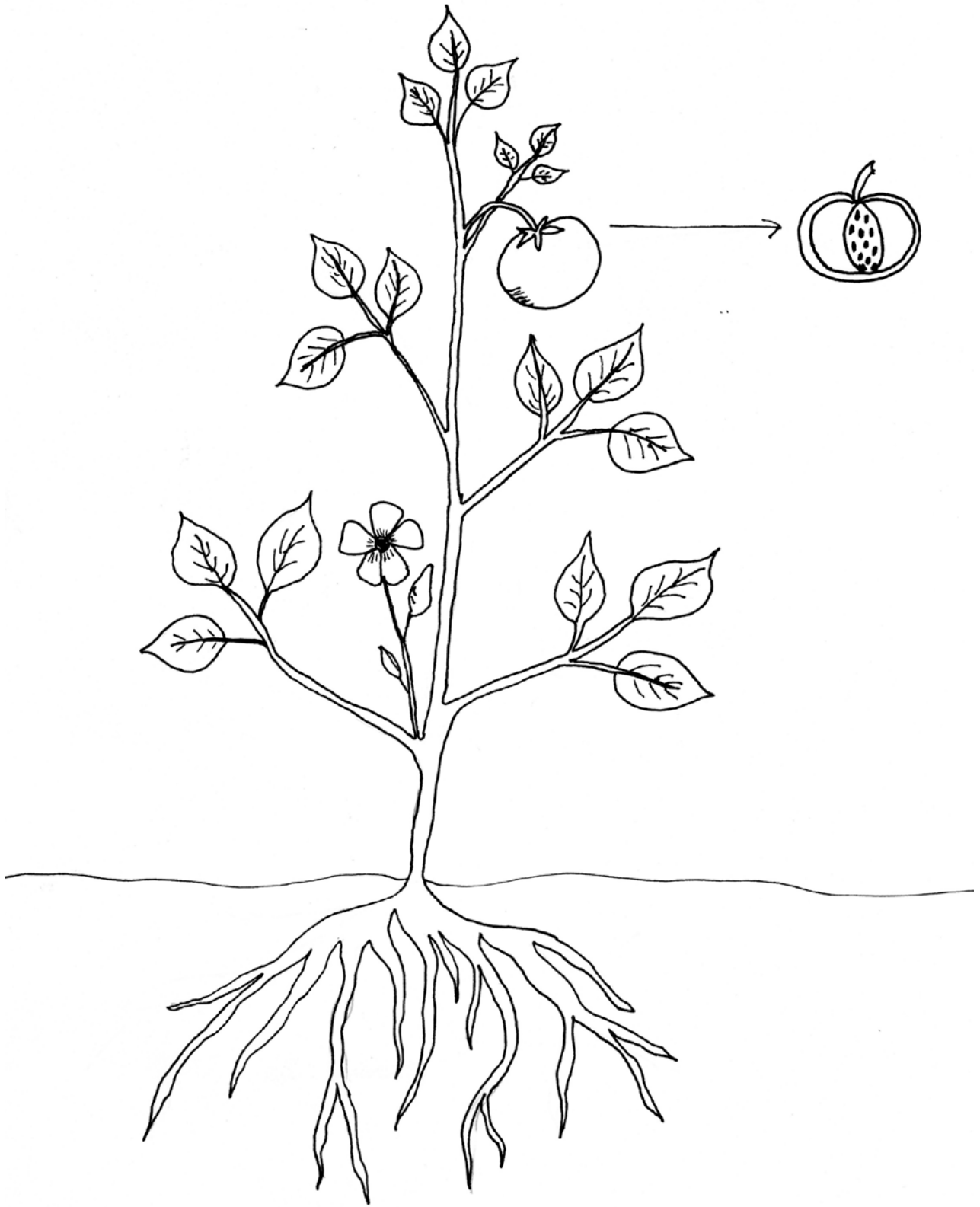

We eat plant parts!

Below are only some of the many plant parts that we eat.

Roots:

Carrot, beet, radish, jicama, yam, turnip, parsnip, sweet potato

Stems:

Broccoli (stem portion), asparagus (stem portion), bamboo (the young shoot), potato (yes, it is an underground stem called a tuber), ginger (an underground stem called a rhizome)

Leaves:

Lettuce, spinach, cabbage, kale, chard, bok choy, collard and mustard greens, herbs such as mint, oregano, dill, and basil

Flowers:

Broccoli and cauliflower heads, artichoke, edible flowers such as borage, nasturtiums, violets, dandelions, daylilies, clover, roses, sunflowers, pansies, and lilacs

Fruits:

Apple, pear, orange, tomato, squash (includes pumpkin), grapes, raisins, green beans and peas (in the pod), nuts (in the shell), tomatillo, strawberry, raspberry, mango, cucumber, avocado, peppers

Seeds:

Peas, beans, and nuts (out of their pods or shells), sunflower seeds (out of their shells), rice, wheat, barley, dill, cumin, sesame seeds, mustard seeds (We use the seeds to make mustard.), corn

The real deal!:

- Any part of the plant that contains a seed or seeds is a fruit. The term “fruit” is a botanical term, the term “vegetable” is a culinary term used commonly to distinguish sweet from savory edible plant parts. So, tomatoes, squash, green beans, peanuts (in the shell), and other savory seed filled plant parts are all fruits.
- Celery is not a stem. It is a petiole, which is the leaf stalk between the stem and the leaf.
- A white potato is not a root. It is a storage stem called a tuber.
- A sweet potato is a tuberous root.
- A banana is a fruit. The seeds in the domestic banana that we eat have been bred out entirely or are so tiny that they look like small specks.
- Corn kernels are fruits.

Objective: Understand the importance of soil for plants and discover soil characteristics.

- Discover what plants need for growth from soil
- Practice observation skills using four of the five senses
- Practice making predictions and observing results
- Follow multi-step directions

Materials

- 1 quart jar with lid
- 5 containers for collecting soil (large enough for 2 cups of soil)
- 5 trowels or large metal spoons for digging up soil samples
- 5 aluminum trays (about 6"x12") or large, sturdy paper plates
- 1 plastic spoon for each student
- Soil jar layer diagram (attached)
- Small plant in a 3-4 inch pot (the plant needs to be easily removed from the pot)
- Checklists for soil observation (attached)
- Clipboard or cardboard piece with clips to hold checklist
- Pencils
- Several sieves (they will get dirty!)
- Magnifying glasses (one for each student if available)
- 5 pieces of paper (about 4x5) on which you write #'s 1-5
- Tape
- 5 sticks at least 12 inches long
- Carrier (bag or box) in which to carry outside supplies



Preparation

- Right before the lesson, gently pull the plant out of its container and put aside with its roots covered by a damp paper towel. Keep the pot and soil close by.
 - Number the containers, and aluminum trays 1 through 5.
 - Number the papers 1 through 5 and attach them to the sticks.
 - Pre-select 5 different areas outside where the students can dig for soil samples. Find areas with as many different types of soil as possible. Mark them with the numbered labels. If the soil is very hard and dry, add some water and loosen it so that the students will be able to dig some up.
- Collect all of the supplies for the outside exploration (trowels, trays, plastic spoons, collection containers, sieves, magnifying glasses, checklists, pencils, and clipboards).

Procedure

Today we are going to play in the dirt! Scientists use the word “soil” instead of “dirt”, so we will too as we are now plant scientists (botanists).

Question: *Why do botanists (plant scientists) study soil? Is it really important for plants?*

- Have students come up with reasons that soil is important for plants. (Provides water, air, nutrients, stability)
- Prompt answers by reviewing last week’s lesson about plant needs. Write the words water, air, nutrients, and space on the board as the students remember them.
- Discuss which of these needs are provided by the soil (water, air, nutrients) and circle them.
- Demonstrate how soil holds up plants by first putting the plant in an empty cup (it falls down), then placing in the cup with water (it sinks slowly), and finish by planting it back into its pot (soil holds it up)

Question: *How do the plants get these things from the soil and grab onto the soil so that they can stand up? (Roots)*

- Gently pull the plant out of the soil again to show the roots.
- Discuss that they are like straws that can pull up water, air, and nutrients. The roots hold onto the soil too.

Question: *What do you think is in soil? Is it all one thing or is it made up of lots of ingredients? We’ll go outside in a few minutes to take a close look at soil around the schoolyard.*

- Spend several minutes writing down ideas about possible soil ingredients on the board.
- Use this list for comparison to a list that the students will do when they bring in the soil from outside.

Outdoor Exploration:

Collect the outdoor supplies and go outside to the designated areas.

- Divide the class into five groups.
- Each group will dig in a designated area.
- Demonstrate that they need to collect soil from the surface and down about 6 inches.
- Show that they will use four of their five senses (no tasting!) to explore the soil.
- Have them spread the soil out on the trays. Demonstrate ways to study it by using sieves to separate out large ingredients, spoons to separate the components, and magnifying glasses to look at the small ones.
- Go from group to group to help students fill out the checklist for each soil sample.
- After about 10 minutes, have each group move, in order, to the next group’s soil to take a look. Allow about two minutes for each rotation. Have them look at and feel the other soils carefully for differences in the soil.
- Bring the soil samples and supplies back to the classroom.

Back in the classroom:

- Line up the trays in front of the room.
- Draw 2 horizontal, parallel lines on the board (about 18-24 inches apart). Add a simple plant with roots going into the soil.

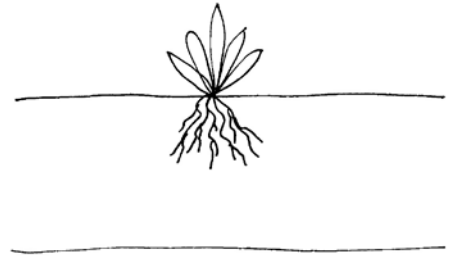

Question: *What did you find in your soil?*

- Make another list next to the one made earlier. If necessary, prompt to get air and water. Add soil creatures too!
- As you make the list of found soil ingredients, have several students come up to the board and draw pictures of the ingredients between the lines.
- Have the students trade trays with another group and spend some time exploring the other group's soil. Trade again if there is time.
- Put about one cup of soil from one or more of the samples in a quart jar. Add water until the jar is about $\frac{3}{4}$ full. Shake it up well and put in an area of the room where it can be seen, but not disturbed.
- Have the students notice how the soil settles out over the next few days. Throw the soil back outside after two weeks or so as it starts to smell!

Let's Review

- *Why do plants need soil?*
- *What was the most surprising thing that you found in the soil?*
- *Did some of the soils smell, feel, or look different? In what ways?*

Keep Exploring

- Experiment to find out how the soil particles will separate differently in each of the samples: (see attached soil layer diagram).
 - Put about a cup of each of the five soil samples in a quart jar that has a lid.
 - Follow the above directions
 - Note how the soil settles after 5 minutes, 30 minutes, 24 hours and after a week or more.
 - Several activities with the jars of soil could include predicting what will happen, measuring the layers, looking at the different sized particles in each layer, and more.

4. It's Not Dirt, It's Soil-K

Name _____ Date _____

If you were a worm in the soil, what would you see as you travel around?
Draw and color what you find:

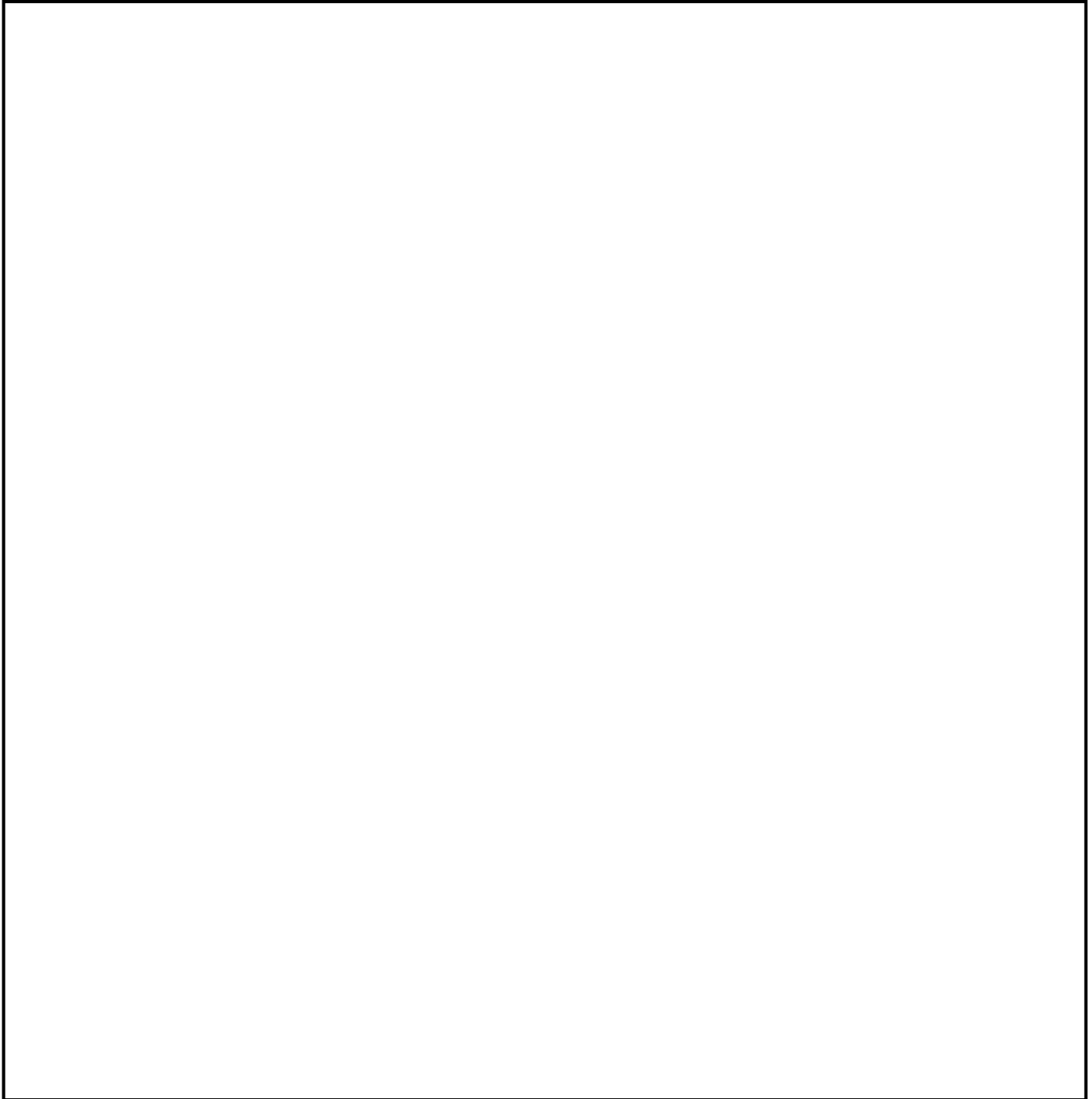

Soil Layers

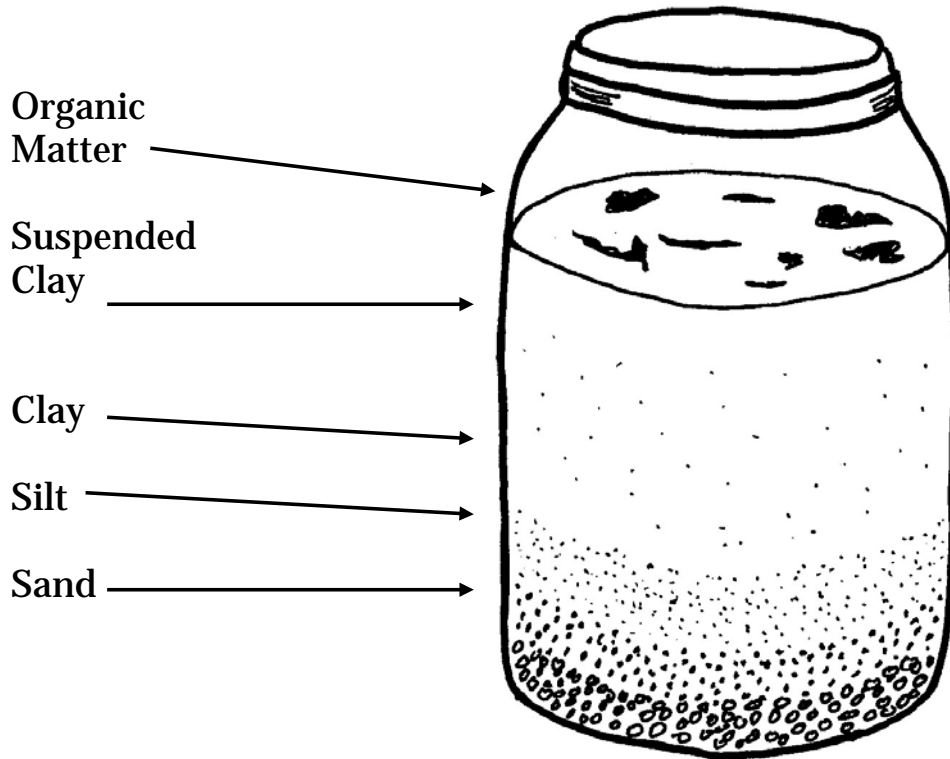

Relative Particle Sizes

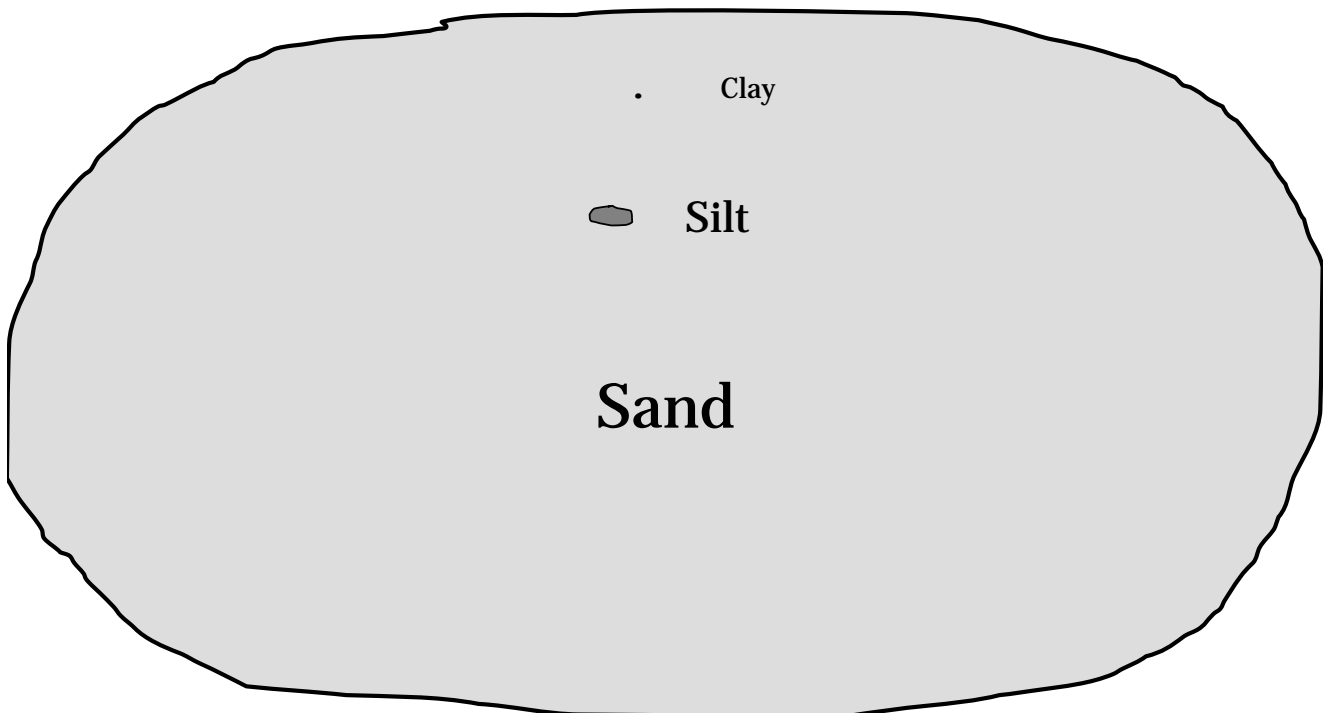

Soil Checklist-K

Soil Sample	Color	Smell	Feel	Sound	What Did You Find?
1					
2					
3					
4					
5					

Objective: Students will collect, identify, and classify soil organisms.

- Discover objects move in many different ways.
- Identify most objects are made of parts.
- Classify objects into given categories.

Materials

- Insect viewers (2 per student + 5 for demonstration)
- Masking tape
- 5 live soil organisms to show the class (ex. worm, spider, centipede, snail, sow bug, etc.)
- Trowels (1 for each pair of students)
- Friend/foe sheets (1 enlarged copy of each), see attached
- Journal page (1 for each student)
- Pencils (1 for each student)
- Clipboard (1 for each student)



Preparation

- Insect viewers can be found at education/teacher supply stores but can be pricey. Check dollar stores or collect your own empty plastic jars such as peanut butter or mayonnaise jars. If you collect your own, you will also need a *small* nail to poke air hole in the lids. Be careful the air holes do not allow your soil organisms to escape!
*Baby food jars could also work if your students are careful with them.
- Collect the soil organisms that you will share at the beginning of class. Put each one in a separate jar and label. Place all jars in a box so that students cannot see the contents of the jars.
- Predetermine places that are approved for students to dig in.
- Enlarge one Garden Friend sheet and one Garden Foe sheet as posters.
- Copy the journal page for each student.

Procedure

Question: We've talked about soil being important to plants so they can live and be healthy. Do you know of anything else that lives in the soil?

- Take students' answers.
- If/when a student calls out a soil organism that you have collected, pull out the jar and show it to the class.
- While the students are passing the jar around, take more answers/pass more jars.

***Explore!** Today we are going to be talking about and looking at soil organisms. We have already looked at 5 different organisms, but you are going to help collect more!*

- Give each student two collecting jars and a partner to work with.
- Give each pair of students a trowel to share.
- Let students know, as partners, they will need to find a different organism for each of their four jars. No repeats!
- Remind students of the safety rules:
 1. Please be gentle when looking in and around the plants to find organisms.
 2. Please be gentle with the organisms themselves. This is their home; we are just borrowing them for a bit before we put them back!
 3. Please walk with trowels pointing down by your side, just like you do with scissors.
 4. Only dig in the places you are allowed to dig for organisms.
- Allow students 10-15 minutes to find their organisms. If they finish early, they can either help another pair of students or just keep looking and digging around.
- After the allotted time, gather the students together again. If it is a hot day, be sure to pick a shady spot. The organisms might “cook” in the jars.

***Question:** Look at all the organisms you found! Are they friends or foes?*

- Many of the organisms are garden friends. They help the garden in some way. (ex. worms help keep the soil aerated. They eat decaying plant material leaving behind nutrient rich castings/poop. They also help make minerals available to plants.)
- Other organisms are foes. This means they might hurt the garden. (ex. too many pill bugs could start eating your live plants and fruits rather than just the decaying matter.)
- Surprise! It is good to have both friends AND foes in the garden. A *balance* is important. Without garden friends, the plants in the garden would not be as healthy. Without garden foes, many of the garden friends wouldn't have food and would therefore leave. We need both!

***Activity:** Friend or foe identification.*

- Have students fill out their journal pages by drawing the organisms they have found.
- When finished, students should look at the posters at the front of the class.
- With their partner, students should decide if their organisms are garden friends, garden foes, or “we don't know.”
- Have students take turns showing their organisms, telling the name of each if they can, and then placing them in front of the Garden Friend or Garden Foe poster at the front of the class.
- If there are any “we don't know,” look at them together.

Let's Review

- *What do you notice about the number of garden friends/foes?*
- *Did we have some of each? Why is it important to have both garden friends and foes?*
- *Let's put our garden organisms back in the garden. Try to put them back in the same area in which you found them.*

Keep Exploring

- Graph the number of friends vs. foes.
- Have students re-categorize the organisms: insects/non, has wings/doesn't, etc.
- Construct a funnel for a living soil experiment. (see attached)

5. Creepy Crawlies – K

Name _____ Date _____

Draw the 4 soil organisms you and your partner found.

Garden Friends



Butterfly



Assassin Bug



Hover Fly



Lacewing



Earthworm



Ladybug

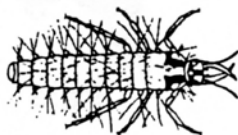

Lacewing Larva



Honeybee



Ladybug Larva



Wasp



Ground Beetle



Spider



Dragonfly



Hummingbird



Frog



Bat

Source: Illustrations are reprinted with permission from *Dead Snails Leave No Trails*, Loren Nancarrow and Janet Hogan Taylor, Ten Speed Press; and *The Bug Book*, Barbara Pleasant, Storey Communications, Inc.

Garden Foes

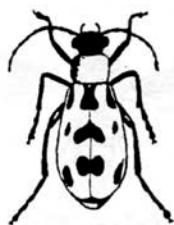

Cucumber Beetle



Grasshopper

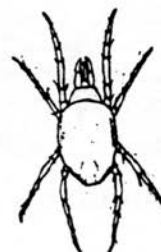

Spider Mite



Aphid



Whitefly

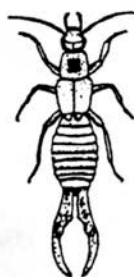

Earwig



Scale



Ant



Harlequin Bug

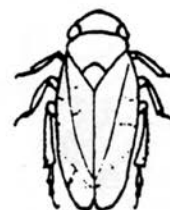

Spittlebug



Pill Bug



Tomato Hornworm



Snail

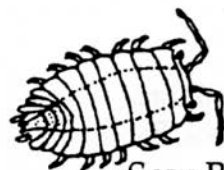

Sow Bug



Gopher



Slug

Garden Friends and Garden Foes

Background Information

Garden Friends

Assassin Bugs



Assassin bugs earn their name because they are such deadly hunters. They feed on many insects including leafhoppers, tomato hornworms, flies, and caterpillars. When you see them feeding they may look like they are kissing another insect, but they are actually using their long, curved beak to inject a paralyzing venom into their prey before they eat it. When you see these bugs in the garden, watch them carefully but don't pick them up—they may bite you!

Bats



Many people are afraid of bats and think that they are dirty, bloodthirsty animals. Bats are actually clean, shy animals that consume huge numbers of insect pests and help to pollinate plants. Bats hunt at night and eat many insects, including moths, leafhoppers, and mosquitoes. A single brown bat can eat up to 600 mosquitoes in one hour! Bats play an essential role in dispersing seeds of plants and in pollinating many flowering and food plants like avocados, bananas, mangoes, dates, and figs. Bat droppings, called *guano*, provide plants with an excellent fertilizer.

Butterflies



Butterflies and moths pollinate more plants than any other insect except bees! Butterflies have chemical sensors on their feet allowing them to “taste” the flowers they walk on. They sip the sweet nectar at the base of flowers through a tube-like mouth called a *proboscis*. Butterflies pick up pollen on their bodies as they feed on the nectar and carry the pollen with them from flower to flower. The pollen fertilizes the flowers, allowing it to produce fruit and seed.



Dragonflies

Dragonflies are fierce predators and eat many garden insects including flies and mosquitoes. The legs of the adult dragonfly hang down to form a basket. Dragonflies catch insects in this basket and eat them as they fly. They can fly at speeds up to 75 miles an hour. Newly hatched dragonflies are called *nymphs*, and they live in water. The nymphs are also predators of other insects, and one nymph can eat as many as 60 mosquito larvae in ten minutes.



Earthworms

Earthworms are not insects; they belong to a group of animals called *Annelida*. Earthworms are essential to the health of your garden soil. They eat and digest dead organic material in the soil and excrete it in droppings, called *castings*, that are rich in the minerals and nutrients that plants need to grow. Earthworms can eat their weight in decaying plant material every day. As earthworms tunnel through the ground, they help to break up the soil, permitting air and water to penetrate. Earthworms also provide an important source of food for birds and other animals that live in the garden.



Frogs and Toads

Frogs and toads love to eat insects. They have fast tongues and can eat between 10,000 and 20,000 insects per year! Amphibians, such as toads, frogs, and salamanders, and many reptiles, such as lizards and snakes, will eat slugs, flies, grubs, cutworms, grasshoppers, and many other insect pests in your garden.



Ground Beetles

There are over 1,200 different species of ground beetles in North America. Ground beetles are predators that eat caterpillars and other soft-bodied insects like slugs, snails, cutworms, and maggots. They prefer to live in dark places, and you will often find them under boards, stones, and logs. Some beetles give off a stinky odor when frightened. Beetles can live for two to three years.



Honeybees

Honeybees are hard workers and our most important pollinators. Honeybees gather pollen and nectar from flowers, and as they fly from flower to flower they pollinate the plants. Bees also produce honey and wax. A bee must make 60,000 nectar-collecting trips to produce one teaspoon of honey! Honeybees can sting, but they do so only when they have been threatened or to protect their nests.

Hover Flies

There are many different species of flies that help to pollinate flowers and keep insect pests under control. **Hover flies** have yellow-and-black or white-and-black stripes and resemble bees. They do not sting, and if you look closely, you will notice they only have one pair of wings. Hover fly adults are important pollinators and are sometimes called flowerflies because they feed on nectar. Their larvae, called maggots, are fat, wormlike creatures that eat large amounts of aphids. **Robber flies** have hairy, bearded faces and are predators that eat beetles, flies, and grasshoppers. **Tachinid flies** look like huge houseflies but you can identify them by the many coarse hairs that cover their bodies. The adults pollinate flowers and eat caterpillars, beetles, and borers. The females lay their eggs on the bodies of insect pests, and when the eggs hatch, the larvae eat the insect host.



Hummingbirds

Hummingbirds are important pollinators and predators of insects. They eat more than one half their weight in food everyday. Hummingbirds are attracted to colorful flowers that produce a lot of nectar. They have long bills and tongues that can extend out into the flowers to help them sip the nectar. In a single day a hummingbird might visit 1,500 flowers! Hummingbirds also need to eat insects for protein, and they feed insects to their young. There are 342 species of hummingbirds in the world and 15 species are found here in North America.





Lacewings

Lacewings are delicate, bright green insects that fly through the garden at night looking for nectar and insects. Most adult lacewings feed mainly on nectar from flowers. When lacewings first hatch from an egg, the larvae are small, brown, oval-shaped creatures covered with tufts of stiff hair. These larvae are hungry predators that use curved jaws, called *mandibles*, to grab and suck the juices out of their prey. They prefer to eat soft-bodied insects, especially aphids, and are such ferocious hunters they have been nicknamed “the aphid lion.”

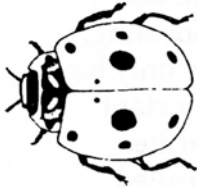

Ladybugs

There are many different species of ladybugs, and most of them are fierce hunters of garden pests like aphids, mealybugs, and scale. Both the adult ladybugs and their young feed on insects. They especially like to eat aphids and will often lay their eggs near aphid colonies. Ladybug larvae are tiny, black and orange creatures less than a half inch long, and one larva can eat up to 500 aphids a day! Adult ladybugs can eat 30 to 40 aphids a day.



Spiders

There are more than 34,000 different species of spiders, and they are some of the most important insect catchers in the world. Although they have terrible eyesight, spiders use their clever hunting skills to catch their prey. Once they catch an insect, spiders sink their fangs into their prey and inject them with a paralyzing venom. Then they feed on the juicy insides of their prey. Spiders are also an important source of food for other garden animals like birds and frogs.



Wasps

There are more than 3,300 different species of wasps in North America. Wasps are considered to be beneficial insects because they eat insect pests. The young of some wasps are parasites—adult wasps lay their eggs on or inside other insects, and when the eggs hatch, the young wasps eat their insect host. Some species of wasps are used in greenhouses to control whiteflies. **Yellow jackets** are one type of wasp that can sometimes become a pest, but they also help us by pollinating flowers and keeping insect pests like caterpillars under control.

Garden Foes

Ants



Ants can be a friend or foe in the garden. When they tunnel to make their homes underground, they help to break up and improve the structure of the soil. They also feed on termites. However, ants like to eat the sweet “honeydew” that aphids secrete. Ants will actually herd the aphids together, protect them, and “milk” them. By protecting aphids, they are protecting a garden pest! Ants live together in communities called *colonies*. There are more ants than there are any other creature on earth. Ants can live about eight years and can lift up to 50 times their own weight.

Aphids



Aphids are tiny, pear-shaped, soft-bodied insects that suck the juices out of plants. One unusual thing about aphids is that they give birth to live young instead of laying eggs like most other insects. One female aphid can have 100 babies at a time, so aphid colonies can grow rapidly. Aphids vary in size, but most are 1/16 to 1/18 inches long. There are many different colors of aphids, including green, brown, yellow, pink, and black. There are both winged and nonwinged species. Aphids produce a sweet, sticky substance called *honeydew* which ants love to eat. This honeydew can coat plants and become a place where a black mold grows.

Cucumber Beetles



Cucumber beetles feed on the leaves of many garden plants including melons, corn, tomatoes, squash, and beans. There are many different types of cucumber beetles. The most common ones are small yellow-and-black striped beetles. Spotted cucumber beetles are larger and prefer to feed on corn. In addition to eating plants, cucumber beetles cause many problems in the garden because they can carry and spread diseases that infect your garden plants.



Earwigs

There are 18 different species of earwigs found throughout North America. These insects are easily identified by the large pinchers on the end of their bodies. Earwigs are both helpful and harmful in the garden. They eat insect pests like aphids and other insect larvae, and as scavengers they help to break down dead organic materials. But they also like to eat the leaves of your plants and can do quite a bit of damage. Earwigs live in dark, dry places and come out into the garden to eat at night. Because earwigs like to hide in dark places, people once incorrectly believed that they would hide inside people's ears—that is how they got the name *earwig*.



Gophers

Not all the pests that live in the garden are insects. Many mammals, like gophers, moles, squirrels, and deer, can become major garden pests. There are 33 different species of gophers, but the most common garden species is the **pocket gopher**, which was named for the pouches or pockets it has inside its cheeks for storing food. Gophers tunnel through the garden leaving fan-shaped mounds where they emerge. They like to nibble on the roots of plants but will often pull the entire plant under the ground and eat it!



Grasshoppers

Grasshoppers are not particular about what they eat and can do a lot of damage to any garden. Grasshoppers eat during the day and use their strong jaws, called *mandibles*, to chew up leaves and stems. Grasshoppers "sing" by rubbing their forelegs together to attract a mate. Grasshoppers provide an important source of food for birds, reptiles, mammals, and other insects like beetles. Some cultures around the world eat grasshoppers as a tasty snack!



Harlequin Bugs

Harlequin bugs have distinctive orange-and-black markings on their backs and are about an inch long. These insects puncture the leaves and stems of plants to suck out the juices. Harlequin bugs love to eat plants in the cabbage family, but they will also feed on beans, squash, and tomatoes. They are related to stink bugs and can release a foul odor when they are disturbed.



Scale

Scale insects cling to the stems and twigs of plants where they suck the juices out of the plant. They are related to aphids, but they have a waxy, shell-like covering that helps to protect and camouflage them. They usually live in clusters or small groups. Many species of scale produce a sweet, sticky substance called *honeydew* which can stick to plants and attract molds.

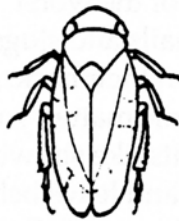

Spittlebugs

If you find a wet glob of what looks like spit on garden plants, you are actually looking at the hiding place of an insect called a *spittlebug*. Spittlebugs are small, hopping insects that are green or brown in color. Young spittlebugs produce a spitlike substance that allows them to hide and also keeps them from drying out. Spittlebugs pierce plant stems and leaves and suck out the juices. They can stunt the growth of plants or kill the entire plant. Some people think that spittlebugs look like tiny frogs, so they are sometimes nicknamed *frohoppers*.

Sow Bugs and Pill Bugs

Sow bugs and pill bugs are not really insects; they are crustaceans and are related to crabs and crayfish. They have hard bodies divided into many segments and ten pairs of legs. Sow bugs and pill bugs are both harmful and helpful in the garden. They act as scavengers and help to break down dead organic material, which enriches the soil. But they will also feed on young seedlings and tender fruits like strawberries. Sow bugs and pill bugs live in dark, damp places, and you will often find them in compost piles and worm bins. Sow bugs are flatter than pill bugs, and only pill bugs roll up into a ball when they are disturbed. Sow bugs breathe through gill-like structures, so they need to live in damp places. You will sometimes find both gray and dark blue sow bugs. They are the same species, but the blue one carries a harmless worm called a *nematode* which gives it its bluish color.



Slugs and Snails

Slugs and snails leave a familiar, slimy trail wherever they travel in the garden. They are one of the worst garden pests here in California. Both snails and slugs are mollusks, but only snails carry a shell on their back. Snails and slugs feed on decaying organic matter, young seedlings, leaves, and low-growing fruits like strawberries. They travel on one, muscular foot and leave behind some slimy mucus which dries into a shiny trail. Snails and slugs hide during the day and come out to feed at night. They love damp weather and will sometimes come out to feed on wet, overcast days. Their eggs look like tiny clusters of pearls in the soil.



Spider Mites

Spider mites are so tiny they look like small dots moving across the leaves of garden plants. Mites are only about 1/50 of an inch long and have eight legs. You will find them on flowers, vegetables, shrubs, fruit trees, and house plants. You may not see the mites, but you may notice leaves that have small yellow speckles, look like they are bleached, or are covered with a fine webbing. Many other species of mites will feed on spider mites to keep their populations down. Research on mites has shown that they will actually reproduce faster when exposed to certain pesticides!



Tomato Hornworms

Tomato hornworms are huge caterpillars whose beautiful green and black markings provide them with camouflage that makes them hard to find on a tomato plant. With their fierce-looking horns these caterpillars look dangerous but they do not harm people. You can often find these caterpillars by looking for their tiny black droppings on the leaves of tomato plants. Tomato hornworms can be a friend or foe of the garden. They are the larval form of a beautiful moth called the sphinx moth which helps to pollinate flowers. But the caterpillar can do a great deal of damage to the leaves of tomato plants—several of them together can eat all of the leaves off a plant!



Whiteflies

Whiteflies are very tiny insects that can do a lot of damage in the garden and to your houseplants. They are relatives of aphids and scale and are only 1/12 of an inch long. Whiteflies are named for the white powder that covers their two pairs of wings. Whiteflies tend to gather in large groups, and when they are disturbed, you will see a white cloud of insects fluttering around the plant. Here in California they are mainly a problem in greenhouses and on citrus trees. Both adults and larvae suck the juices out of a plant and tend to hide underneath the leaves. Adult whiteflies excrete a sticky substance called *honeydew* which can stick on the plant and promote diseases such as a mold called *sooty black fungus*.



Source: Illustrations are reprinted with permission from *Dead Snails Leave No Trails*, Loren Nancarrow and Janet Hogan Taylor, Ten Speed Press; and *The Bug Book*, Barbara Pleasant, Storey Communications, Inc.

PROCEDURE

for building and using a Berlese Funnel

Here's what you need to make a Berlese Funnel:

- a one-gallon plastic milk container (empty)
- an empty jelly jar (or a one-pint Mason jar) with a tight lid
- a stick -- about 25 cm long
- 1/4" mesh hardware cloth or aluminum window screen (15 X 15 cm)
- a pair of scissors
- masking tape or duct tape
- rubbing alcohol (ethyl) -- available at drug stores
- a gooseneck lamp (optional)

Assembly:

1. Cut the bottom out of the milk jug (Fig. 1) and turn it upside down over the Mason jar to make a funnel.
2. Tape the stick to the handle of the milk jug (Fig. 2) so it is just long enough to reach the outside bottom of the Mason jar.
3. Bend down the corners of the hardware cloth so it fits snugly inside the wide end of the funnel. If using window screen, cut and pinch numerous slits so larger animals can crawl through.
4. Collect several handfuls of humus or leaf litter and put them on top of the wire mesh.
5. Pour alcohol into the Mason jar to a depth of 1-2 cm.
6. Carefully set the funnel on top of the jar and tape the stick to the jar so it won't tip over.
7. Leave the funnel in a warm, quiet place where it won't be disturbed.
8. Set a lamp over the funnel to speed drying (see Fig. 3). Keep the lightbulb at least 10 cm away from the funnel.

Figure 1

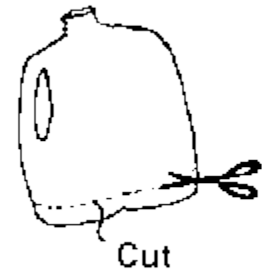

Figure 2

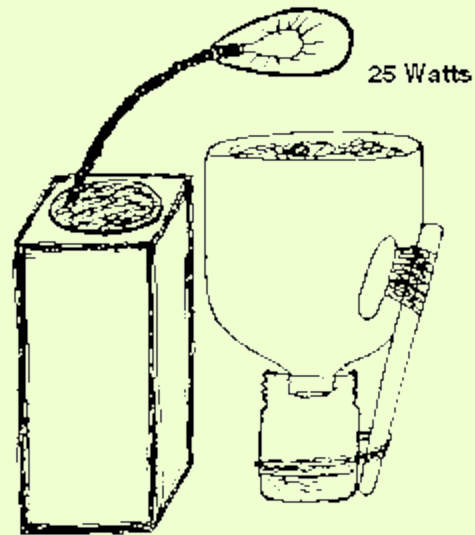
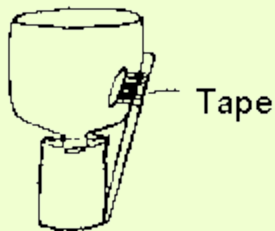

Figure 3 – Completely Set Up

As the sample dries out, the animals will move down and fall into the alcohol. After 4 or 5 days (maybe longer if the sample was quite wet), you can CAREFULLY remove the jar and screw on its lid. The alcohol will preserve the sample indefinitely.

<http://www.cals.ncsu.edu/course/ent591k/berlese.html>

John R. Meyer
Department of Entomology
NC State University

Objective: Students will use their senses and observation skills to identify and classify objects in the garden.

- Recognize the physical characteristics of their surroundings.
- Classify objects into given categories.
- Learn new words through listening and reading widely.

Materials

- Chart paper
- Easel (optional)
- Markers
- Two interesting plant pieces with distinct, opposite features (ex. Lamb's Ear and Horse Chestnut)
- Demonstration egg carton
- Empty egg cartons (1 per group of 4 students)
- 1 color paper with 2 differing adjectives (1 for each egg carton)
- 1 blank color paper slip to match the slip with adjectives written on it
- Paper clips (one for each carton)
- Marker (one for each group)
- Timer/clock/watch



Preparation

- Collect several samples of two different plant pieces (ex. Lamb's Ear and Horse Chestnut)
- Collect items for a demonstration egg carton. Use the top row of an egg carton to display the items that are described by one adjective (ex. round), and the bottom row to display the items that are described by the other (ex. skinny). Write the two adjectives that describe your objects on a slip of paper.
- Write pairs of adjectives for each of the student cartons (examples of plant adjectives attached). Use a different color paper for each carton. Fold this paper in half so students cannot see the words written.
- Cut matching slips of paper to match the paper with adjectives written on it. There should be 2 slips for each egg carton. (ex. Egg carton #1 will have 2 blue papers: 1 blank paper and 1 with adjectives written on it.)
- Attach matching color papers to the cartons with a paper clip.

Procedure

Observation:

- Have the students pass the Lamb's Ear leaves.
- Allow them to call out their reactions/descriptions. Write their words on chart paper or a whiteboard.
- Remind them to use their different senses (except taste!), and to try to use as many different words as they can (no repeats!).
- Do the same with horse chestnuts. Make a separate list.

Question: *What do you notice about these two different plant pieces?*

- Take answers. Add any new words to the respective lists.
- Read the two lists.

Question: *Look at all the words you used to describe these two small plant pieces. Words that describe things are called adjectives. Let's talk about more adjectives. Here is an egg carton filled with different garden objects. The top row can all be described with one adjective, and the bottom row can all be described with another. Using your observation skills, which adjectives do you think describe these objects?*

- Have children look at the egg carton and pass if necessary.
- Take suggested adjectives.
- Reveal the two words that were written to describe your objects. Talk about multiple words meaning the same/similar thing (synonyms).

Explore! *Next I'm going to give YOU two adjectives and an empty egg carton in which you will go into the garden to find objects that match.*

- Remind students of the 3 guidelines for picking in the garden:
 1. Try to find non-living objects that are already on the ground.
 2. Only pick something if there are more than 20 of them.
 3. Use the two hand picking rule: hold the part you want to remain with one hand, and pick with the other. (Avoids ripping up whole plants, branches, roots, etc.)
- Students should use the top row of an egg carton to display the items that are described by one of the adjectives, and the bottom row to display the items that are described by the other.
- Remind students to not "spill the beans" as to which types of objects they are looking for! Later other students will be using their observation skills to determine which adjectives describe the objects found.
- Have students carefully and secretly look at their adjective paper.
- Explore! Give students 10 minutes to collect their objects.
- If students finish early, they may add more objects to their carton in their respective rows.

Activity:

- Call students back to a whole group setting. They should sit clumped together with their respective groups.

- Have groups keep their own “secret” adjective papers, but trade egg cartons with another group.
- Each group needs to observe the objects in the new carton.
- As a group they need to determine/agree upon the adjectives being represented, and write the words/pictures on the blank piece of paper attached to the carton.

Elaborate:

- After 3 minutes or so, have groups take turns sharing the adjectives they used to describe objects in their new cartons.
- Ask the class if they agree or disagree.
- Ask, “What did you observe that leads you to conclude that?”

Let’s Review

- All cartons should go back with their original groups.
- Have the groups reveal their own “secret” adjective papers.
- *Do the adjectives describe the objects?*
- *What evidence did the group have?*
- *Which senses did they use?*
- *Is there more than one way to describe the objects in the carton?*

Keep Exploring

- Pass around new adjectives for students to find objects for.
- Have students create pairs of new adjectives for others.

6. Six of One, Half Dozen of the Other-K

Name _____ Date _____

Draw one object that were in the **top** row of your egg carton.

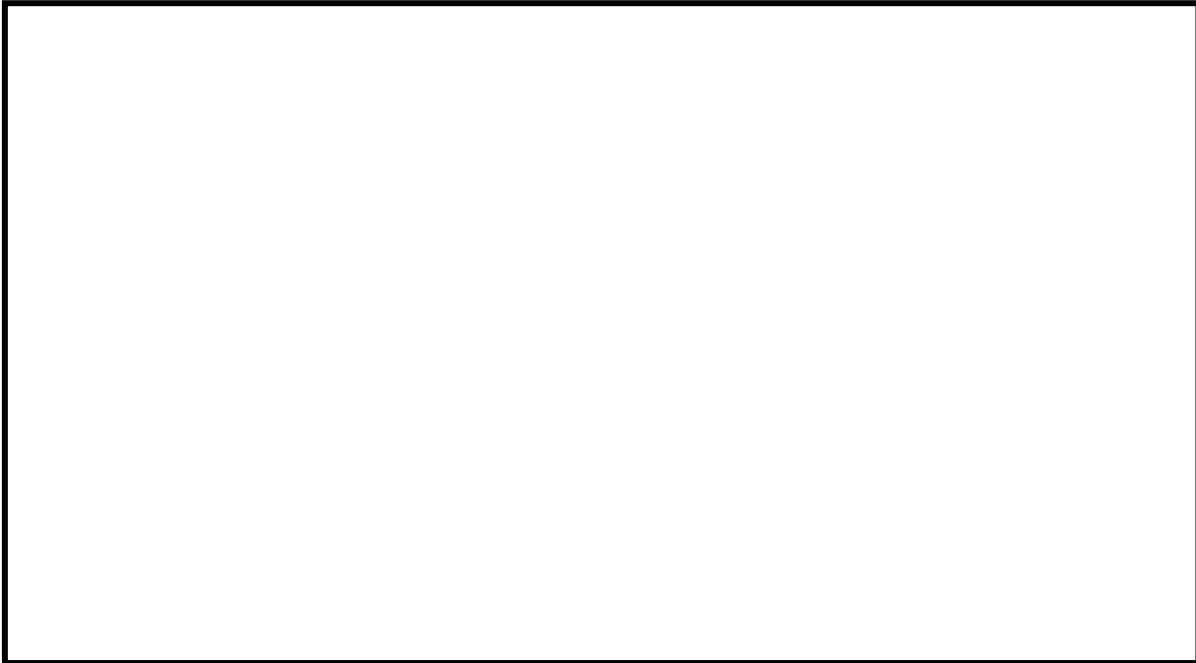

Draw one object that were in the **bottom** row of your egg carton.



Plant Adjectives and Antonyms

	round		skinny
	green		brown
	soft		hard
	shiny		fuzzy
	smooth		rough
	smelly		no smell
	colorful		dull
	wet		dry
	dark		light

Objective: Students will plant garlic and spinach.

- Describe measurable attributes of ingredients in a recipe.
- Describe measurable attributes of objects, such as length when planting.
- Gain an understanding of companion planting.

Materials

- Garlic-Spinach recipe (attached)
- 1 cup measuring cup
- 1 tablespoon measuring spoon
- 2 serving spoons
- Mixing bowl
- Cheese grater
- Garlic press/knife and cutting board
- Colander
- 3 bulbs of garlic (the farmer's market is a great source)
- 1 bunch fresh spinach (the recipe calls for frozen)
- 1 cup mayonnaise
- 1 cup sour cream
- ½ cup grated parmesan cheese
- 1 lemon
- 10 oz. package frozen chopped spinach, thawed
- Veggies for dipping (carrots, celery, broccoli, etc.)
- 1 small plate for each person
- Spinach seeds
- Ruler
- Watering can
- Water



Preparation

- Print/enlarge the garlic-spinach recipe.
- Gather ingredients and materials. (Farmer's Market garlic will be better for planting. You will know it was not sprayed with growth inhibitor as many grocery store varieties are!)
- Pre-cut the veggies that are served with the dip.
- Lay out all of the ingredients for the dip on a table.

Procedure

Question: Take a look at the items on this table. Does anyone know which of these items are parts of a plant?

- Garlic, spinach, and lemons. (Hold them up as students name them.)

Explore! Let's make something with these ingredients that we can eat today! We are going to use this recipe to help us make garlic-spinach dip.

- Call up students to help with each ingredient.
- The recipe says it is best to let the dip sit for a while before eating it.
- Let students know they will be able to eat it at the end of the lesson.

Activity: How many of you would like to eat the dip, not just today, but other days too? Let's plant our own garlic and spinach so that we can harvest fresh ingredients in the spring! (It is too cold in the winter in Salt Lake City to grow lemons.)

- To plant garlic, break apart the bulb into individual cloves while keeping the paper part on. By choosing the biggest cloves to plant, you will harvest bigger garlic.
- The cloves grow best when they are placed pointy side up (the roots grow down, the sprout shoots up).
- The cloves are to be planted about 4 - 6 inches apart and 2 inches deep. Ask students what this means. What does it look like?
- Tell students it would be a little bit difficult and take a lot of time to use a ruler to plant each clove of garlic. Today they will use their hands as measuring tools instead.
- Demonstrate the following: I know that the width of my hand is 4 ½ inches (show on the ruler). And I know that my thumb is two inches long. That means to plant garlic, I can stick my left thumb in the soil, lay my right hand next to it, and then put a second hole with my left thumb on the other side of my right hand. (Emphasize the alternating pattern.) My garlic will then be 4-6 inches apart and 2 inches deep.
- Have a student come up to see how his or her hands measure. How will students be able to plant with their hands rather than rulers? A pointer finger and two hands? What measures to be 4-6 inches and 2 inches?
- Ask students why it is important for us to measure at all. (Plants need space to grow!)

- To plant spinach, students do not need hand measurements.
- The seeds are so small; they do not need as much space.
- Have students sprinkle the seeds on the garden next to the garlic and then "tickle" or lightly cover the seeds with soil.
- Water the garlic and spinach seeds.

Question: Why did we plant the garlic and spinach together? Did you know plants can be friends?

- The garlic needs space to grow underground but spinach likes to have space above. That means they can share garden space.
- Little insects called aphids like to eat spinach. They hurt the plant so people can't eat it any more. However, aphids DO NOT like garlic. By planting the spinach by the garlic,

the aphids are more likely to stay away. The garlic is protecting the spinach. It is being a good friend.

Let's Review

Question: We learned a lot today about following recipes, measuring, planting garlic and spinach, and how plants can be friends! What is one new thing you learned today? If someone takes what you were going to say, share a different thing you learned. No repeats!

- Have students take turns answering.
- As a student gives a new answer, he/she can go get a plate of garlic-spinach dip and veggies.

Keep Exploring

- Try making other foods that feature garlic and/or spinach.

7. Plants Are Friends Too – K

Name _____ Date _____

Draw yourself planting garlic and spinach.

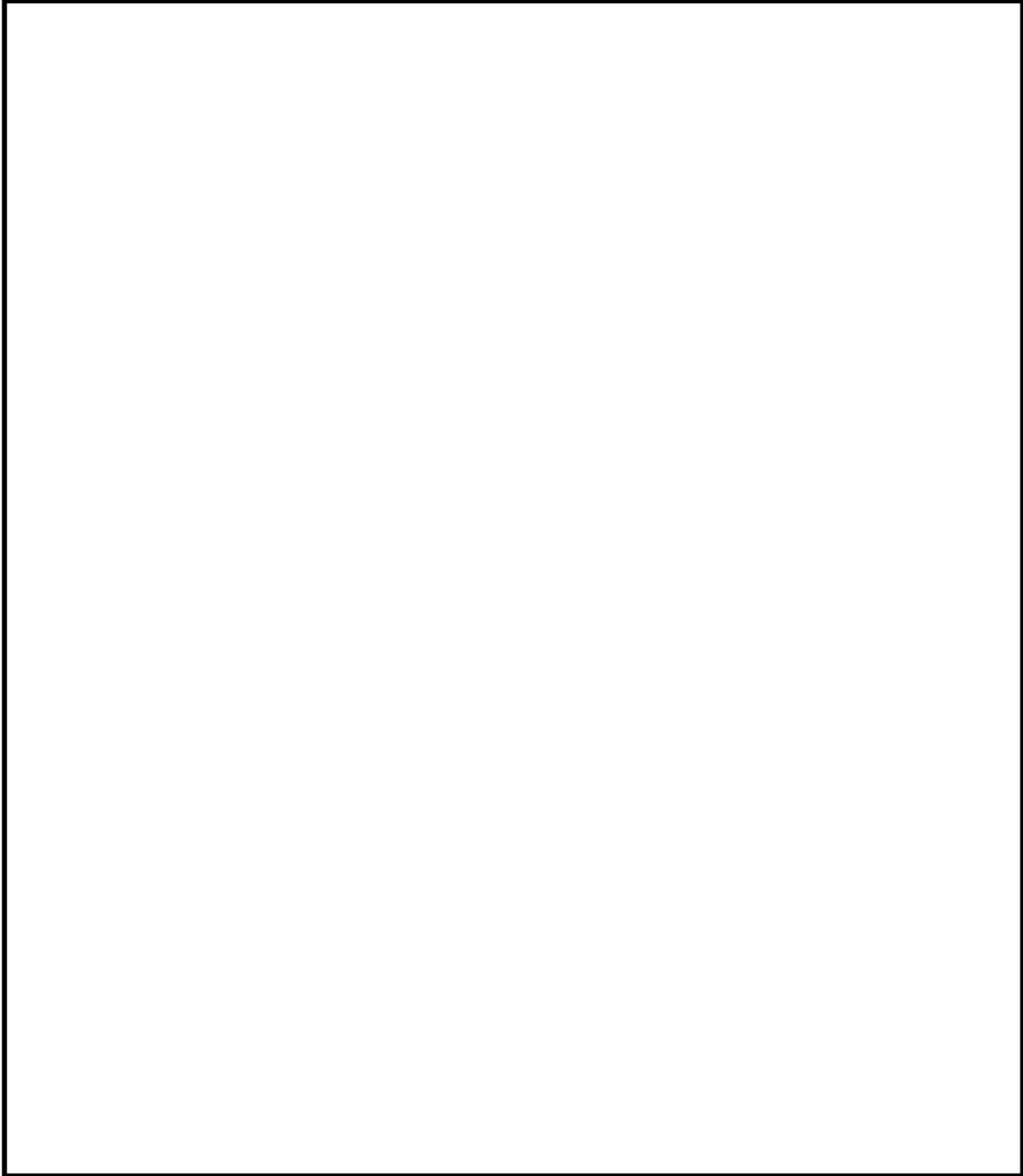

Garlic-Spinach Dip

Prep: 5 min., Chill: 1 hr.

Spread on crackers or served alongside fresh vegetables.



YIELD: Makes 20 servings (serving size: 2 tbsp.)

Ingredients

- 1 cup mayonnaise
- 1 cup sour cream
- 1/2 cup grated Parmesan cheese
- 1 to 2 garlic cloves, minced
- 2 tablespoons fresh lemon juice
- 1 (10-oz.) package frozen chopped spinach, thawed and well drained
- Assorted crackers
- Assorted fresh vegetables

Preparation

1. Stir together first 5 ingredients in a medium bowl until blended.
2. Stir in spinach.
3. Cover and chill at least 1 hour or up to 2 days.
4. Serve with assorted crackers and vegetables.

Southern Living Cooking School APRIL 2007

<http://www.myrecipes.com/recipe/garlic-spinach-dip-10000001616534/>

8. A Pumpkin Is a What?

Objective: Students will dissect different foods to determine whether they are fruits or vegetables.

- Identify most objects are made of parts.
- Classify objects into given categories.

Materials

- 6 baskets/containers
- Relay labels (attached)
- Relay cards (attached)
- 12 different fruits and veggies (3 sets if using real food for the relay game)
- Cutting board
- Knife
- Journal pages (page 1: 1 per student, page 2: 1 per 2 students)
- Scissors
- Glue



Preparation

- Print two sets of relay labels. Attach them to the baskets.
- Print two sets of relay cards (if you are not using real food for the relay game). Cut them apart. Have one set in a basket for each team. Or have an identical set of food in a basket for each team.
- Print journal pages.

Procedure

Engage: Fruit and Veggie Relay

- Split the class in half to form two lines.
- Show the students the two labeled baskets that are about 30 feet in front of each line.
- Let students know the object of the game is to be the first team to put the fruits/veggies/relay cards in the correct basket.
- Place a container with the fruits and veggies or the relay cards at the front of each line.
- The person at the front of the line must choose one fruit/veggie/card and run to put it in the appropriate basket.
- Once that runner tags the person at the front of the line, the next runner can pick up a fruit/veggie/card.
- Ready-Set-Go!
- Continue until all fruit/veggies/cards have been put in a labeled basket.

Observation: *Let's see what was placed in the fruit and vegetable baskets.*

- Dump out the contents of each basket in respective piles.
- Go through one by one naming each of the items.
- Ask the students if they agree or disagree about the placement of the items. Ask why but don't move any items to different piles.

Question: *What is the definition of a fruit? What is a definition of a vegetable?*

- A fruit is the part of the plant (the mature ovary) that contains seeds.
- A vegetable is the part of the plant we eat that does NOT have seeds.
- Often people categorize fruits as plant parts that are sweet, and vegetables as plant parts that are not sweet. As botanists, you will learn this is not true.

Explore: *We are going to dissect/cut each of the foods we used in the relay to see if they have seeds or not. This will tell you if the food is a fruit or vegetable. Remember, fruits have seeds, vegetables do not.*

- One-by-one, cut open each of the foods.
- Have students look, touch, smell, and name each food.
- Have students determine if each food has seeds and is a fruit or not.
- Put fruits in one pile and vegetables in another.

Activity: *Look at all the fruits and vegetables we have. How do you know which ones are fruits? (the ones that have seeds!) Let's record the data we found today in our journals.*

- Have students complete their journal pages.
- Leave the piles of fruits and veggies for them to refer to.

Let's Review

- Look at the piles of food/cards that are still laid out from the relay at the beginning of the lesson.
- Ask students, using the information they have learned, if they would change the placement of any of the items.
- Change items if necessary so fruits and veggies are in their respective piles.
- Collect all the items and put them back in the team baskets.
- Have students redo the relay from the beginning of the lesson.
- Reinforce that the goal of the relay is to be the team that gets all the foods in the correct fruit or veggie basket.
- Once the relay is over, go through each of the baskets. Ask students if they agree/disagree.
- Move the food to the correct category if it is not already there.
- Optional: give a prize to the team(s) that has a perfect score!

Keep Exploring

- Harvest pumpkins that were planted at the end of the previous school year.

- Carve the pumpkins.
- Estimate number of pumpkin seeds.
- Weigh the pumpkin whole, after removing the seeds/guts, and after carving.
- Toast the pumpkin seeds.













8. A Pumpkin is a What?- K













Name _____ Date _____

Cut out the pictures of food. Glue each picture in the correct box.
Remember fruits have seeds, and vegetables do not!

Fruit

Vegetables

			
apple	avocado	celery	cucumber
			
green beans	jicama	onion	orange
			
pear	potato	squash	tomato

			
apple	avocado	celery	cucumber
			
green beans	jicama	onion	orange
			
pear	potato	squash	tomato

Fruit and Vegetable Cards



apple



avocado



celery

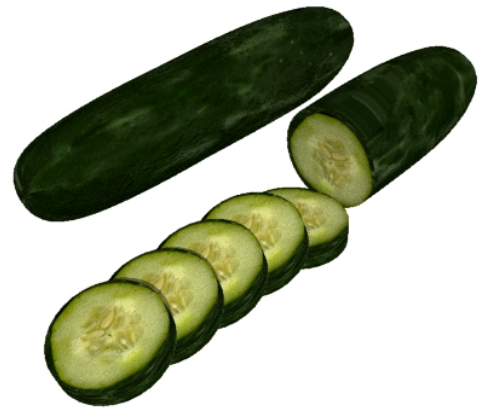

cucumber



green beans



jicama



onion

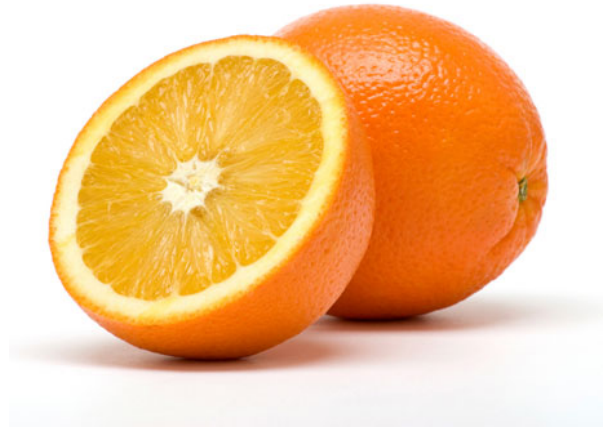

orange



pear



potato



squash



tomato

Fruit



Vegetable

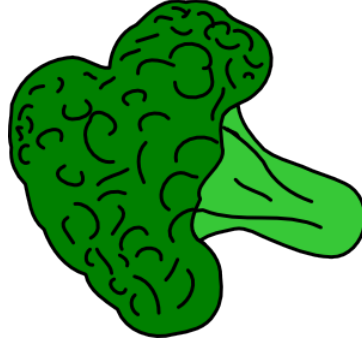

9. It's Chilly Out Here!

Getting Ready For Winter In The Garden

Objective: Learn how plants prepare to survive through the winter.

- Practice observation skills
- Learn about plant survival adaptations
- Understand seasonal changes in the environment

Materials

- Collection of plant materials from outside (see preparation)
- Adaptation checklist (attached)
- Insect winter survival (attached)
- 2 brown paper bags
- Clipboard or piece of cardboard (size of adaptation checklist)
- Enough straw to cover the garden plot with several inches of protection. Plan to share a bale of straw with other teachers in the garden program. Local suppliers are:
 - AA Callister (3615 South Redwood Road, West Valley City, UT 84119, 801-973-7058)
 - IFA (1147 W 2100 S. Salt Lake City UT 84101, 801-972-3009).
- Garbage bag for the straw
- Camera (optional)



Preparation

- Collect plant materials from the school grounds. Look for a variety of seeds and seedpods, leaves with different shapes, textures, and colors (include evergreens such as pines), stems with buds, pieces of bark (from the ground, not pulled from the tree), and berries.
- Choose areas for the students to explore in which they will be able to find the plant adaptations listed on the observation sheets.
- Put an assortment of materials in the 2 paper bags.
- Print out observation sheet and attached to the clipboard or cardboard.

Procedure

Have the students sit in a circle on the floor.

***Question:** What are some of the things that are happening outside right now that let us know that winter is on its way? (Some answers to look for are colder temperatures, leaves changing colors and falling, shorter days, and early snow.)*

Question: *What are some of the things that we do to stay warm in the winter?*

- Prompt for answers such as closing doors and windows, putting on warm clothing, and turning up the heat in our houses or apartments.

Question: *What do animals such as bears do in the winter? (Hibernate)*

Observation: *I'm going to pass around some other things that get cold in the winter and need to change so that they can survive. First you will carefully feel the objects in the bag without looking at them and try to figure out what they are. Then we'll take a look!*

- Pass the 2 bags around starting each at the same time going in a different direction around the circle.
- When the bags are back at the beginning, ask students what they think was in the bags.
- Take out the materials and have the students move in closer.
- These plants are adapting to winter too, just as we do. Show an example of each of the different adaptations: some leaves change colors and then fall from the trees so that the branches don't break under snow; buds are protected by tough and sometimes furry "coats"; evergreen leaves stay on the trees and have thick outer layers for protection (pine needles are leaves too); and seeds form for next spring's growth.
- Pass several of the materials around again and have the students carefully look at, feel, and smell the objects.

Let's go outside to see what we can find!

- Review the outside garden rules and remind the students to not pick or damage any plant materials.
- Take out the adaptation checklist on the clipboard, a pencil, camera (optional) and gathered plant materials.

Outside Exploration:

- Spend a short time in a group looking around to see how many trees they can spot. Then see how many different leaf colors the students can find.
- One at a time, explain the plant adaptations, show an example from the collected materials, and then explore to find an example in the schoolyard. Divide into smaller groups if you have other adults present.
- Spend some time with each discovery looking, smelling and feeling.
- Check each discovery off of the checklist and do a quick sketch if you'd like.
- If possible, take pictures of your "finds" to print out and display with your collection of found materials.

Activity: *The plants in our vegetable garden need our help to survive the winter too. We'll clean it up and put on a straw covering for protection. We'll also keep watering the plants a bit until the ground freezes.*

- Demonstrate what needs to be done for cleaning up. Pull out and discard weeds and dead plant material, but don't pull out your crops!
- Supervise closely as the students carefully finish the cleaning process.
- Give each student a handful of straw to place carefully around and lightly over the plants.

Extra Exploration: If there is time in this class session, explore the topic of insect adaptations to winter survival. Where do some of the students' favorite garden insects go in winter? See "Keep Exploring" below.

Let's Review

- *How do you stay warm in the winter?*
- *What would you do if you were a plant and winter was coming?*

Keep Exploring

Insects need to adapt to winter too! Learn what insects do to survive when it's cold. The use of plants is often involved! See the attached information.

9. Winter is Coming!-K

Name _____ Date _____

Draw a tree with colorful leaves that is getting ready for winter:

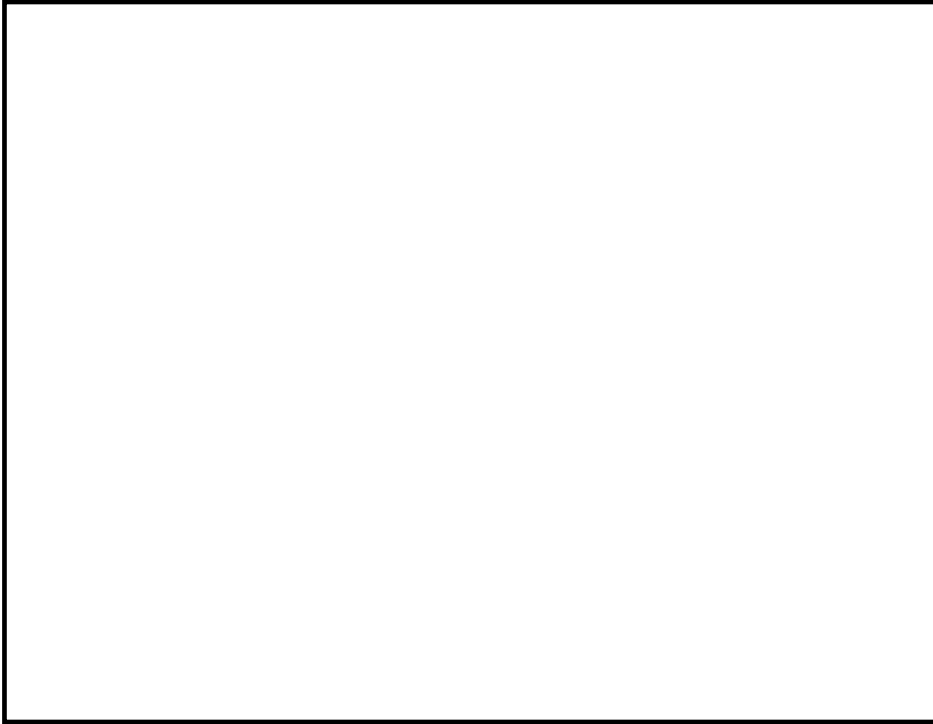

Draw yourself getting ready for a cold day:











Name _____ Date _____

<u>Adaptation</u>	<u>Your Drawing</u>
A colorful leaf	
A bud	
Seeds and berries	
An evergreen tree	

Winter Survival

Insects, worms, and spiders have many means of survival in the winter. The main techniques are communal living, leaving eggs and nymphs for next year's population, using "antifreeze", migration, dormancy, freezing, and hibernation. Below are a few of students' favorites. See what others you can learn about!

<p style="text-align: center;">Earthworms</p>	<p>Some dig deep below the frozen soil and coil into slime coated balls and go into a sleeplike state similar to hibernation (estivation). Some lay eggs that can survive freezing closer to the surface and then die off.</p>	
<p style="text-align: center;">Honey Bees</p>	<p>Bees eat their stored honey all winter and cluster in a tight ball around the queen. The vibration of their wing muscles helps to heat up the area.</p>	
<p style="text-align: center;">Native Bees</p>	<p>Native bees are usually solitary and hibernate in the ground, under leaf litter, or in tree holes for the winter.</p>	
<p style="text-align: center;">Ants</p>	<p>Ants stay in their inside of their communities during the winter eating stored food and using a separate chamber for waste.</p>	
<p style="text-align: center;">Butterflies</p>	<p>Monarch butterflies migrate to Mexico in the winter. The ones that return to here are actually the children of the ones who left, as those die on the way back. Many other types of adult butterflies die off, in fall, leaving behind eggs, pupae, or larvae to overwinter on leaves, in leaf litter, under bark, in soil, and other sheltered areas.</p>	

<p>Dragonflies</p>	<p>The adults die every year leaving behind nymphs that live in water (they have gills). They hibernate deep under the water in mud and can live for several years before becoming adults.</p>	
<p>Ladybeetles (ladybugs)</p>	<p>The adults migrate to warmer areas and form huge clusters in sheltered areas. These can be in tree hollows, under leaf litter, or even in our houses. They go into a state called diapause that is similar to hibernation.</p>	
<p>Daddy Long Legs</p>	<p>These are actually not spiders, but a relative of spiders. They find a protected area and gather by the hundreds into fist-sized balls for warmth.</p>	
<p>Woolly Bear Caterpillar</p>	<p>This larva of the Isabella Tiger Moth develops a type of antifreeze called glycerol that reduces the cells' susceptibility to freezing. The caterpillar actually freezes, but the ice crystals form very slowly and are small enough to not pierce the cells. Many other insects use this method as well.</p>	

10. The Worms Crawl In- Decomposition

Objective: Students will set up scenarios to observe three different types of decomposition.

- Understand the term decomposition.
- Recognize change happens to many things.
- Identify some changes are so slow that they are hard to see.

Materials

- Whole, ripe melon
- Knife
- Cutting board
- Big bowl for the seeds and rinds
- Toothpicks
- Three identical plastic containers with lids, ideally 12" x 9" x 6" or bigger
- Small nail to make air holes
- Two gallons finished, moist compost (or soil if you do not have access to compost)
- Compost Critters poster (attached)
- Handful of red wiggler worms (see Acquiring Red Wigglers section at end of lesson)
- Newspaper



Preparation

- Buy a ripe melon.
- Make air holes in the lids and tops of the sides of the plastic containers.
- Collect finished compost or soil.
- Collect or buy red wiggler worms.

Procedure

Let's Eat!

- Cut the melon in half.
- Scoop the seeds onto a plate/bowl.
- Cut the melon into pieces. Add the rind to the seeds on the plate/bowl.
- Use the toothpicks to distribute melon pieces to students to eat.

Question: What do you think we should do with these seeds and rind? (Most students will respond throw it in the garbage.) Let's watch it decompose!

Experiment: Today we are going to set up experiments in which we can watch the process of decomposition. That means, over time, we will see the seeds and rind of our melon break down/rot. Water, weather, something eating them, something smashing them, or mold can all influence decomposition.

- Take out the three identical plastic containers.
- Have students add a ½ gallon of compost/soil to the bottom of **two** of the containers.
- Have them look for living organisms. Let them know that they may see big compost critters (show examples from the poster), but they may not be able to see all the living organisms in the compost/soil (point out the mold/bacteria examples on the poster).
- Explain that there are living organisms everywhere! Just like germs that we can't see, there are other organisms that we can't see either. Some of these organisms are decomposers, they help eat our garbage. Without them, we would live a really stinky, junky place! This experiment will show just that.
- In the first container, the one without compost/soil, place 1/3 of the seeds and rind.
- In the second container, place 1/3 of the seeds and rind on top of the compost/soil.
- In the third container, place a handful of **red wigglers** then 1/3 of the seeds and rind.
- Cover the second and third containers with a ½ gallon compost/soil each.
- **IMPORTANT!** To avoid a fruit fly infestation in your classroom, you should fill the rest of the air space in the containers with torn strips of newspaper. Fruit flies reproduce in the air. Without that airspace, the fruit flies will finish their life cycle without reproducing more. (Tip: the newspaper will tear in even 1" strips if you tear it lengthwise.)
- Cover all three containers with the plastic lids with air holes.

Question: What do you think will happen in each of these containers? One has just melon seeds and rind. Another has melon seeds and rind but also has soil with living organisms that we cannot see. The third has melon seeds and rind, soil with living organisms that we cannot see, and red wiggler worms. (Take students' answers.)

Outdoor Exploration: Let's go outside and look for signs of decomposition. Remember, decomposition is when something that was once alive is now breaking down or rotting. We will go on a tour of the garden/schoolyard together. If you see something decomposing, yell, "Decomposition!" We will all look at the item together and try to see what is making it decompose. Is it water, weather, something eating it, something smashing it, or mold? Please be sure to leave all items where they are so they can finish decomposing.

Let's Review

- What is decomposition?
- What is our experiment going to show us? (Decomposition/change in the melon seeds and rind?)
- If we were to sit and watch our plastic containers for 5 minutes, will we see a change in our melon seeds and rind? Why not? What about an hour? (The bacteria, mold, and worms are much smaller than we are and take a long time to digest the melon scraps.)

Keep Exploring

- Once the melon seeds and rind have finished decomposing, try different foods. Do some things decompose faster than others? Are some things smelly while others are not? What do the worms like best/eat the fastest? (AVOID meat, dairy, and grease! It won't be good for the worms, could be VERY smelly, and/or the meat could carry disease.)

Acquiring Red Wigglers

- Do you know someone that vermicomposts? (Someone that composts with worms and has a worm bin.) Ask him/her for a small handful.
- Contact Wasatch Community Gardens 801-359-2658, or www.wasatchgardens.org. They will most likely have worms to share with you from their worm bin or be able to refer you to someone who does.
- Contact Chuck Squires at Rott'n Apple Worm Farm in central Utah. He sells Red Wigglers by the pound. You could split the pound between several classrooms to share for this lesson! Order worms at rottenapplewormfarm.com, call him at 435-558-0826, or see him at the Downtown Farmer's Market in Pioneer Park.
- ***Please note** that red wigglers are different than the earthworms you find when digging in soil outside. Earthworms live, dig, and tunnel through the soil. Red wigglers are surface eaters and would most likely be found under a pile of leaves or manure. If you try to put earthworms (*Lumbricus terrestris*) in containers in your classroom, you will quickly find that they have escaped to get back to their 50 degree soil. If you try to put red wigglers (*Eisenia fetida*) in containers in your classroom, you will find that they are happy as can be to eat your food scraps for you! Be sure to get red wigglers for this experiment!

10. The Worms Crawl In- K

Name _____ Date _____

Draw what your experiment looks like the day you set it up.

#1

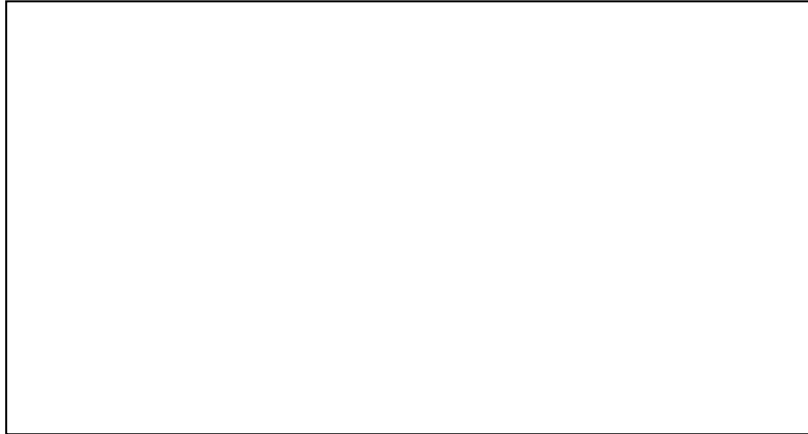

#2



#3



Draw what your experiment looks like after 2 weeks.

#1

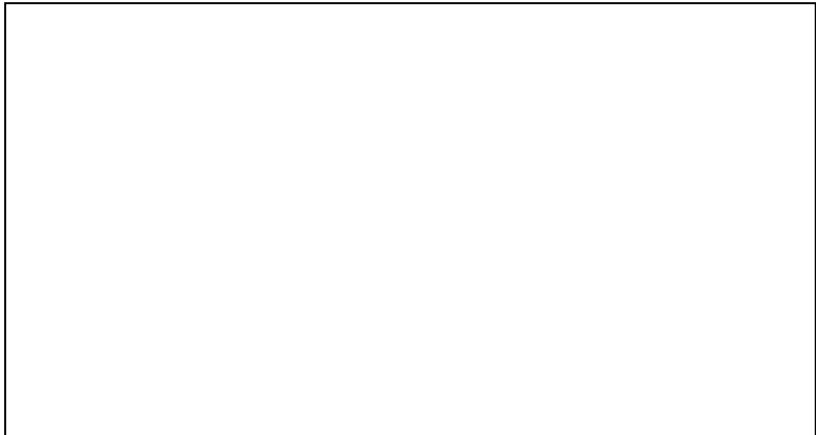

#2

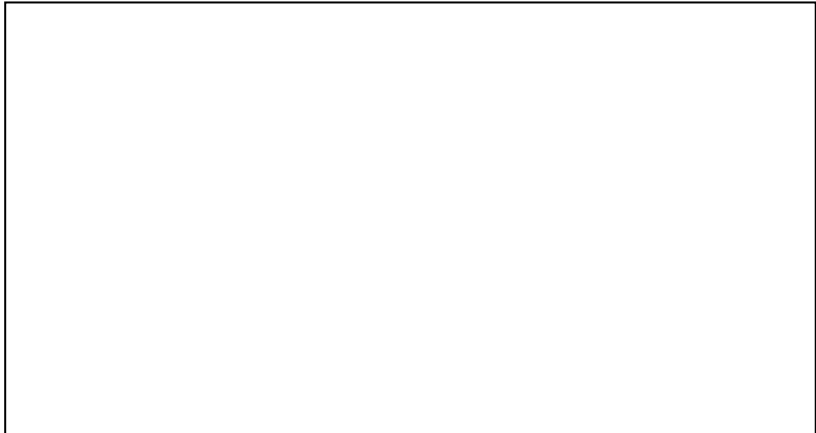

#3



COMPOST CRITTERS WORKSHEET

CIRCLE ME IF YOU CAN FIND ME



COLLEMBOLA



SPRINGTAIL



MITE



WORM COCOON

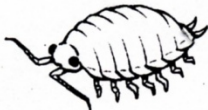

SOW BUG



SLUG



WHITE WORM



FRUIT FLY



BEETLE



REDWORM



SPIDER



SNAIL



MOLD



ANT



MILLIPEDE



CENTIPEDE

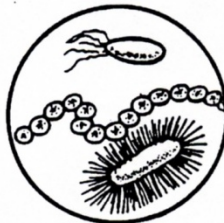

BACTERIA



PILL BUG

Compost Critters Information Page

Slug

I have muscular discs on my undersides that are adapted for creeping and crawling. I lay eggs masses that look like jello. I eat living material but will make an appearance from time to time in your compost pile to eat fresh garbage and garden trimmings.



Mite

I am tiny. I would take 25 of us to cover an inch-long line. My body is round and fat so it's hard to see my 8 legs. I eat plant materials such as mold and soft tissues of leaves. Some of us eat manure of other organisms. I am usually white or brown.



Millipede

I have so many legs you would have a hard time counting them. My name means "thousand legs," but I don't have that many. I am very shy and I roll up in a ball to avoid danger. I am a vegetarian and eat soft, moist, decaying plants. I am dark-red in color and am 1 to 3 inches long.

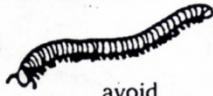

Springtail

I am a tiny insect less than $\frac{1}{16}$ inch long. I eat molds and decaying materials. I have a little spring that helps me jump high into the air. I am white in color.



Collembola

I am a close relative of the springtail but I can't jump. I am tiny, and less than $\frac{1}{16}$ of an inch long. I eat molds and decaying matter. I am white in color.



Beetle

I am an insect with shiny black, tough wings and am about $\frac{1}{2}$ inch long. I am a predator and eat slugs, snails and soft insects such as caterpillars. I live beneath stones, boards and other moist places.

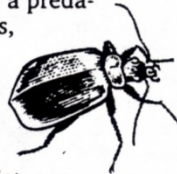

Snail

Like my friend, the slug, I am a mollusk and creep around on my muscular belly. I carry on my back a spirally curved shell. I also have a broad retractable foot and a distinct head. Like slugs, I prefer to eat living material, but I will also show up in your compost pile or worm box from time to time for lunch.



Spider

I am related to mites and have 8 nifty legs. I am one of the least appreciated animals in the garden and compost. I feed on other insects and work hard to help control pests that will hurt a garden.



Worm Cocoon

You can find me in a worm bin or compost pile. Before I have hatched, I am clear and yellowish and the shape of a lemon, and $\frac{1}{8}$ inch long. After I have hatched I turn pea green. Two or more baby worms are hatched at once.



Compost Critters Information Page

Pill Bug or Roly Poly

I am an isopod, which means I have ten pairs of legs that look very similar to each other. I eat old leaves and veggie scraps. I am about 1/2 inch long and I roll up in a ball if I am disturbed. Some people think that I look like a little armadillo. I am a greyish, dark color.



Centipede

I move quickly on my many legs. I have 15-137 segments with a pair of legs on each. I am a fierce hunter. I love to eat earthworms. I use my pair of poison claws to help keep my prey from getting away. I am about 1 to 2 inches long. I am usually reddish brown.



Ant

I am an insect with 6 legs. I help to decompose by breaking materials into smaller particles. I create tunnels, and move soil into clumps. Some people would rather not have me around their homes. I am black, brown, or red.



White Worm

I look like a frayed piece of thread. I am a skinny, white worm. I am 1/2 to 1 inch long. I am related to an earthworm. I like to eat rotting food after the other bugs get to it. You might think of me as one who likes to finish off the job.



Bacteria

We are so tiny that you can't even see us. We are everywhere. I am colorless. I can eat almost anything. Some of us live together in groups and others don't.



Mold

I am a fungus. I am related to mushrooms. Most of us live on old food. You might see me on old food in your home or your worm bin.



Sow Bug

I have 10 pairs of legs. That makes me an isopod like my cousin the Roly Poly. I eat vegetation and old leaves. My 1/2 inch long body is oval and flat with flattened plates, but I can't roll up into a ball like Roly Poly. I am related to crayfish and lobsters. I breathe with gills, so I must live in a damp, moist place. I am a dark, greyish color.



Earthworm

I am a long, thin soft-bodied animal. My body is made up of little segments. I do not have legs or eyes. I sense light and I breathe through my skin. I eat bacteria, fungi, and other decaying materials. I like dark, moist places.



Fruit Fly

I am a very small fly. People don't like me, but I don't bite, sting, or make buzzing sounds. I don't harm earthworms either. Sometimes you will see me around a worm bin if a person forgot to bury their food. I like to lay my eggs where it's moist and warm.



Source: *Do the Rot Thing: A Teacher's Guide to Compost Activities*, Alameda County Waste Management Authority & Source Reduction and Recycling Board, 1993.

Objective: Learn how plants are used in everyday life

- Practice observation skills
- Learn interviewing skills

Materials

- List of plant uses (attached)
- Plant related articles from home (see attached suggestions)
- Interview sheet (attached)
- Checklist sheet (attached)
- Plant use pictures (attached)
- Large piece of paper for the tree diagram (see below) 3'x3' would work well.
- Marker

**Preparation**

- Print out a checklist sheet
- Print out an interview sheet
- Print out plant use diagrams for classroom display (attached)
- Ask several people in the school such as the principal, office staff, cafeteria director, librarian, and teacher from another class if you can stop by their area at a designated time so that your students can look around, take notes on their checklists, and do a quick interview. (See the school tour section below.)
- Select three objects from your home collection and the classroom (i.e. an apple, chopsticks, and a pencil) to use for the opening demonstration.

Procedure

I'm going to show you three objects and I want you to tell me what they have in common.

- Hold up the objects and take some guesses.
- Prompt until someone comes up with the fact that they all originate with plants.

Question: Wow! We know that we all eat plants, but did you know that there are thousands of other uses for plants? Can you think of some?

- Let the students come up with as many plant uses as possible. You can prompt thinking by pointing out that they, and you, are all wearing a plant-cotton!
- Write all of the suggestions on the board in a list. You will be adding to this list, so leave plenty of room.

Explore!

Let's become Plant Use Detectives by exploring our room to find as many things related to plants as possible. Each time we find something we'll add it to our list.

- As items are found, try to figure out from what type of plant or plant part they come from (tree, flower, seed, etc.).
- When the students have found everything in the room related to plants (refer to the attached list for some ideas of things that might have been missed), bring out the objects that you brought in from home.
- Again, explain from what plant or general part of the plant each thing comes. If you do not know, this could be a topic for further class research.
- Put the plant use pictures on display and talk about any new plant uses.

Let's explore some places in the school for more plant uses. Put on your Plant Use Detective glasses!

- Take the checklist on the tour.
- Explain that this will be a **silent exploration**.
- They will walk in the appointed areas and raise their hands when they spot a plant use. They will tell the class and you will write it on your checklist.
- When you get to the interviewees, have the students stand or sit quietly as you find out how many plant uses the person can figure out. Write the answers on your interview sheet.
- Let the students teach the interviewee about some additional plant uses that he or she may not have thought of!
- Return to the classroom.

Question: *Do you use plants at home too?*

- Have a discussion about all of the ways to use plants at home too.
- Prompts can include having them think about meals, clothing, sheets on their beds, musical instruments, the structure of the house, furniture and more

Let's Review

You have all been great Plant Use Detectives and now know a lot about how we use plants. I'm going to draw a picture of a tree on this large paper and we are going to write down as many ways as possible that we can use trees. We'll include animals and insects too.

- Draw the tree and draw lines out to the uses (see example for suggestions).
- Add ones that the students come up with and more!

Question: *Do you think that your friends and the people in your family know as much as you do now about all of the ways that plants are use? Do you think that they might be surprised at some of the uses? Be Plant Use Detectives after school too and ask your friends and family members about plant uses. We'll talk about their answers tomorrow.*

- Follow up on this the next day, if any of the students remember to ask!

Keep Exploring

- Write a class story about the "The Day the Plants All Disappeared".
- Research the world of George Washington Carver and all of the things that he invented from peanuts, soybeans, and other plants.

Curricula funding provided by The Humana Foundation for the Salt Lake City School District

11. Plant Use Detectives-K

Name _____ Date _____

Draw your favorite way to use plants:

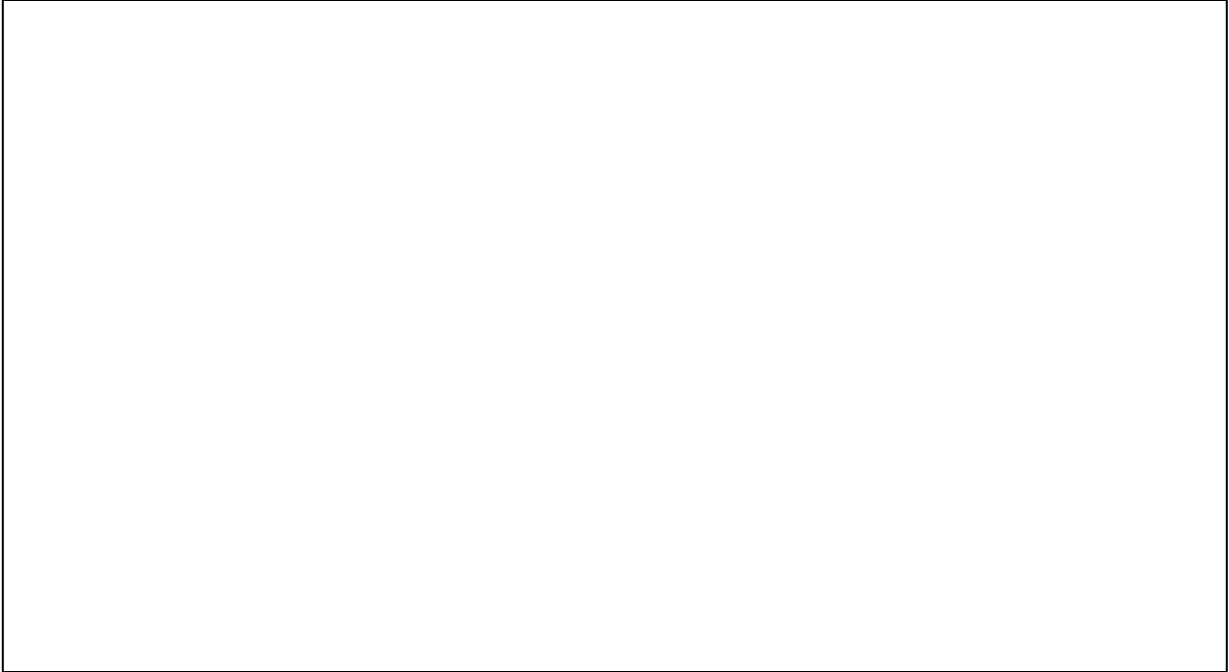

Birds use plants too! Draw a bird in her nest in the tree:



**These things
come from
plants!**







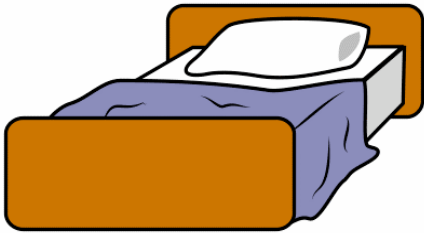



















**This is the
plant!**



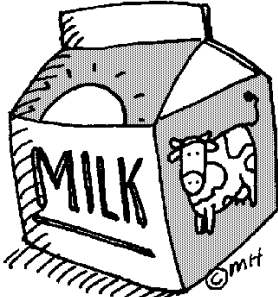







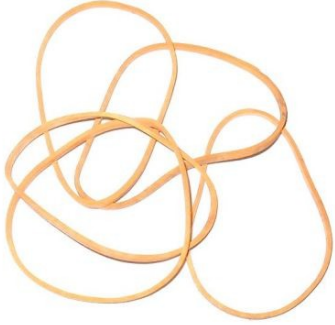







Plant Uses

Adhesives

Art (to make and to observe)

Axel grease

Beautification inside of homes, businesses, hospitals

Boats

Bomb detection (Really! See research from Colorado State University)

Charcoal

Chewing gum

Christmas trees

Clothes

Cork boards and wine corks

Cosmetics

Erosion control

Food

Food and shelter for animals and insects

Fuel

Furniture

Herbs and spices

Ladders

Lamp oil

Landscape beautification in parks, homes, businesses

Linens (sheets, towels, napkins, table cloths, etc.)

Lumber

Medicines

Musical instruments

Oxygen

Paints

Paper

Pencils

Recreational equipment

Rope

Shade

Shelter

Soap

Soil amendments

Stains

Toothpicks

Toys

Turpentine

And more!

Examples of plant related products to bring from home:

Cosmetics, soap, clothing, aspirin, oils, newspaper (paper from trees and ink from soybeans), food items, herbs and spices, chopsticks, toothpicks, wooden picture frames, decorative pictures of plants, baseball bat.

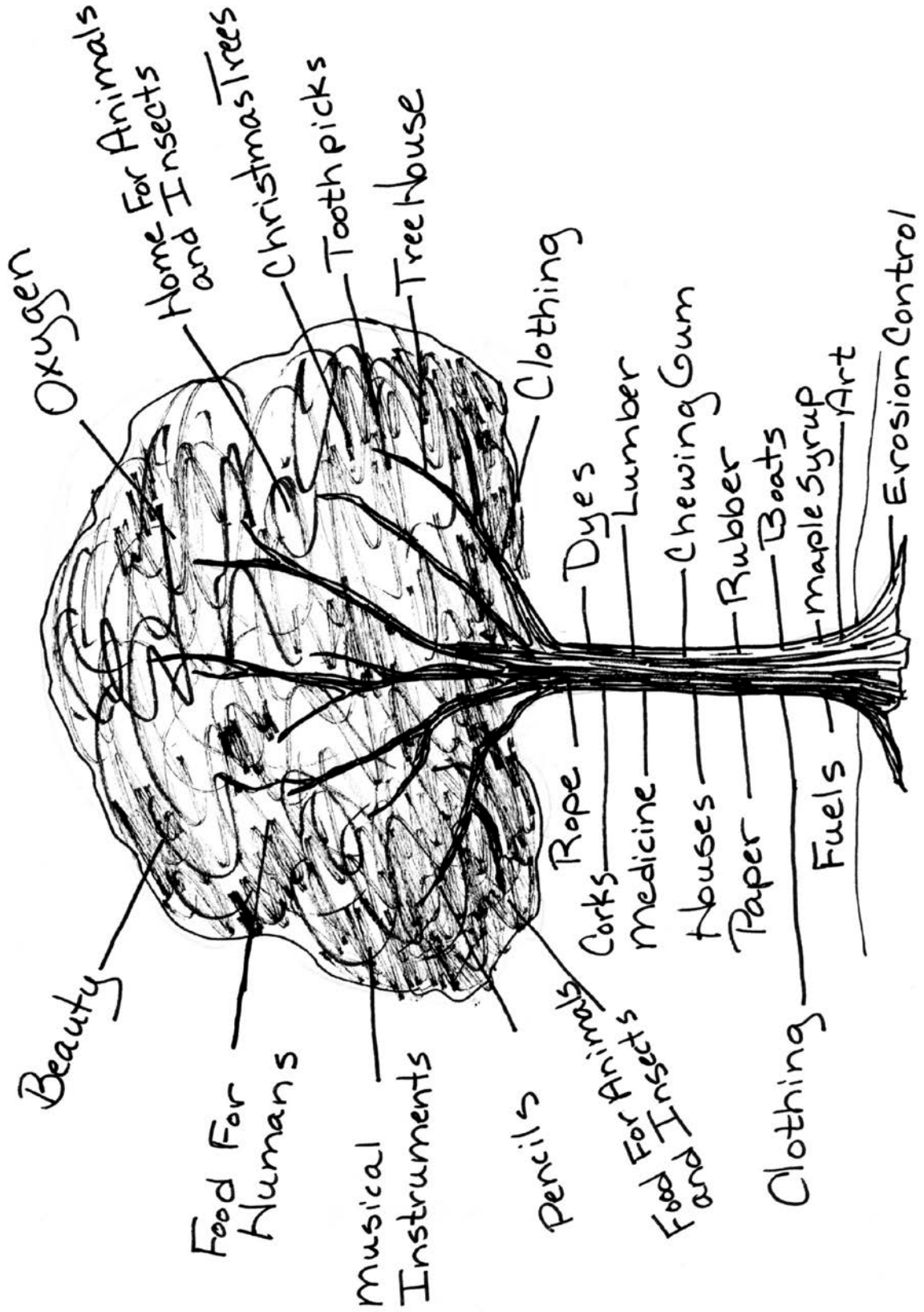

Plant Detective Interviews

Name _____ Date _____

I interviewed	They use plants for:

Objective: Students teach each other about different plants in the garden.

- Identify and describe the properties of plants.
- Develop language through listening and speaking while giving presentations to their classmates.
- Observe and understand there are cycles and changes in the garden, and that change happens to many things.

Materials

- Information Cards
- Materials needed for the optional activities (see below)



Preparation

- Pick enough parts of a plant (i.e. leaf or flower) to give to each student.
- Identify (but don't pick) 12 or more different plants/items of interest in the garden that you know. The theme of this month is Changes in the garden. Try to choose samples from different parts of the plant cycle (ex. green leaf, red leaf, dry leaf, flower, fruit, seed, empty stick, budding branches, etc.)
- Information cards are helpful to many students for this lesson. There are a few examples attached, but you will have to make your own depending on what is in your garden/schoolyard.
- If you need help finding 2 interesting facts about a plant, Google the plant name. There will be many gardening websites with descriptions to help you.
- Have another adult to be with the waiting group.

Procedure

Engage!

- Hold up your example plant piece.
- Let students know in a little bit, they are going to have to go into the garden and find from which plant your leaf came.
- There are so many plants, this could be a difficult task. Ask students how they can help themselves. (Look, feel, smell, and even listen, but DO NOT taste!)
- Hand a plant piece to each student. Have them take the time to observe (look, feel, smell, listen) BEFORE going out into the garden.
- Let children know that they should walk carefully around the garden and use their plant pieces to compare to the other plants.

- If a student believes he/she found the plant in which the pieces came from, he/she should raise a hand and yell out, “I found it!”
- At that time all students should gather around the child who found the plant. As a class they should decide if they agree or disagree and why.
- If the class disagrees, everyone spreads out again to keep looking.
- If the class agrees, the teacher tells the class about the plant. For example, “This is called arugula. This plant is fun because you can eat both its leaves AND its flowers! The leaves are a little bitter, but young flowers taste like peanut butter! Remember it is only ok to taste something in the garden if you are **invited** to pick and eat it. Right now I invite you to taste a flower first and if you like, the leaves too.”
- Remind students of the two hand picking rule: Hold the main part of the plant with one hand and pull a piece off with the other. This is the friendliest way for the plant. One hand picking could result in pulling a big chunk or even the whole plant up. The plant might not survive this.

The Botanists’ Hike: Now each of you will have the chance to teach the rest of the class about a plant in our garden!

- Have the class assemble in an open area.
- Let students know they will have an activity while they are waiting (see below) but they must also be looking for the signal that it is their turn to go on the hike.
- Take a pair of students to the first plant. Tell them the name of the plant as well as 2 interesting facts about the plant. Be sure to include whether or not it is edible to humans!
- Once you have finished explaining, have this first pair of botanists give the signal/raise their hands to signal they are ready for the next pair of students.
- The second pair of students will listen to/learn what the first pair of botanists teach about the first plant. Then you will lead this second pair to a second plant while the first pair signals to the group to get a third pair of students. At the next signal, the first pair will have a fourth pair and the second pair will have the third pair. At the next signal, the first pair will have a fifth pair, the second pair will have the fourth, and the third will be learning with you.
- Continue this cycle until the last pair that was waiting has learned from the first pair at plant #1. At that time, the first pair will wait while the last pair learns about plant #2. Once the last pair has moved on to plant #3, the first pair can go learn about plant #2. After, the first and second pairs will go together to learn about plant #3. Each pair will join the group in a snowball effect so that the last pair from the group that was waiting teaches the rest of the class together just one time.

Tips:

- Put students in pairs ahead of time. The more independent/outgoing/talkative should go first. The quietest/shyest should go last as they will only present once and will have more access to your help/assistance.
- Have students leave garden plants as is unless **invited** to pick and eat!

Possible activities for the assembled group that is waiting to go on the hike:

- Write a letter to a pen pal at a different school garden.

- Read a story.
- Have students add questions/answers to the class Question Book.
- Journal/draw

Let's Review

- Each person shares one new thing he/she learned on the Botanist Hike.

Keep Exploring

- Have students identify plants they already know that weren't on the hike. Have them tell you about it. If they have correct information, allow them to teach the class about "their" plant.

12. The Botanists' Hike – K

Name _____ **Date** _____

Today you were an expert botanist. Draw the plant you taught about.



The Botanists' Hike Information Cards



basil

- Basil is a great companion plant to tomatoes; it helps keep aphids away when grown next to each other!
- Basil is also a good companion plant to tomatoes because they taste great together.
- YES! You can taste it.



borage

- This plant tastes like cucumbers.
- The leaves are fuzzy though, so the flowers are the best part to taste.
- Grab the middle and pull gently, if it comes off easily it is ready. If it doesn't, try a different one.
- YES! You can taste it.



crab apple

- This fruit is bitter.
- Usually people make preserves or cider out of it rather than eat it raw.
- YES! You can taste it, but you might want to take a small bite.



rabbitbrush

- Native to Utah.
- Provides shelter for small mammals and birds.
- Deer, elk, small mammals, and birds eat it in the winter.
- YUCK! Do not taste it.

The Botanists' Hike Information Cards

BASIL



Good with tomatoes.



YES! Eat it!

BORAGE

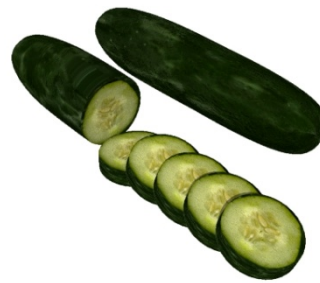

Tastes like cucumber.



YES! Eat it!

CRAB APPLE



Make jam or jelly.



Yes. Taste a little.

RABBITBRUSH



Deer and birds eat it.



YUCK! People don't eat it!

13. We All Work Together!

Each Plant Part Has a Job

Objective: Review the names of plant parts and learn about the job of each part.

- Use investigative skills.
- Sharpen observation skills
- Make hypotheses and draw conclusions (with Lesson 14)

Note: This lesson is to be combined with Lesson 14 for a complete view of plant parts.

Materials

- 5 small live plants with flowers (a variety if possible)
- 1 fruit that contains lots of seeds such as a tomato or kiwi
- Several sheets of newspaper for each plant
- An old soft paintbrush or toothbrush
- Plant part job list (attached)
- Knife to cut fruit
- 2 tall glasses or jars
- Red or blue food coloring
- 2 pieces of celery (best with leaves left on if possible)
- Small magnifying glasses (one for each student if available)
- 1 “juicy” leaf for each student (spinach works well)
- Plant diagram



Preparation

- Prepare an area at each group's table for the plant investigation. Lay down several layers of newspaper and put out the magnifying glasses.

Procedure

We've looked at parts of plants that we eat, plants that are growing outside, and drawn pictures of plants. Today you will look very closely at all of the parts of a plant and try to figure out if a plant really needs all of those parts.

- Carefully pull each plant out of the pot and brush off the excess soil before putting it on the newspaper. Save the soil and pots for a later activity.
- Put a plant on each table on the newspaper. Let the students know that they are to look at the plant very carefully and treat it gently.
- Give the students time to really look at, touch, and smell the plant. Have them study the plant with the magnifying glasses as well.

Question: Do you see all of the plant parts here? Let's list the parts that we can see (roots, stems, leaves, and flowers).

On the board, draw a line representing the soil line and then a picture of a plant with the parts as the students say them. Label the parts.

Question: There are two parts missing from these plants. What are they? (fruit, seeds)

- Show the fruit sample.
- Cut it into 5 pieces making sure there are seeds in each piece and give one to each group.
- Have the students take some time to study the fruit and seeds.
- Add these to the plant drawing.

Question: Do you think that plants really need all of these parts? Let's look at ourselves first to help answer this question. Do we have body parts? How do they help us?

- Have a short discussion about this topic.

Question: So you see that our body parts work together to help us. How do you think these plant parts help the plant? Do you think that they really need all of the parts?

Let's set up some experiments to see how some of the parts work. We'll start with roots.

- Pick up two of the plants (the ones that look the best!).
- Carefully repot one of them.
- Cut the roots off of the other one, fill another pot with soil, and "plant" the stalk.
- Label the pots "With Roots" and "Without Roots".
- Tell the students that you will water both of them when the soil is dry and that they will observe the plants over the next seven days or so for differences in the plants' appearance.
- Roots pull water out of the soil for the plants. What do you think will happen to the plant without roots?

Next we'll look more closely at stems.

- Fill one glass with water and one with water and about 6-10 drops of food coloring.
- Give the stalks of celery a fresh cut and put one in each glass.
- Place them in a sunny window.
- Tell the students that they will observe any differences in the stalks the **next** day.

We'll finish today with leaves and learn more about flowers, fruit, and seeds during the next class.

Question: How many of you have plants inside or outside of your home? Did you feed any of them breakfast this morning? How do you think that plants get their food?

- Have a short discussion about these questions.
- Plants are very special. They make their own food!
- Hold up a leaf. Plants make their own food right inside of their leaves.
- We cannot see what is happening inside the leaf, but leaves are like kitchens for the plant.

Question: When we make food to eat in the kitchen, like pizza, we need ingredients. The leaves need ingredients too to make food for the plant. Can anyone think of what these might be?

- Take some answers.
- The correct answers are water, air, sunlight and one more “magic” ingredient.
- Give each student a spinach leaf. Have them look carefully at the leaf and then crumple it up and rub it on their palms until the green sticky substance comes out. Have them hold up their green hands!
- This green stuff on your hand is the “magic” ingredient! It is called chlorophyll. You can feel some of the water that is in the leaf too.
- The plants use all of these ingredients to make a type of sugar for food. You can feel the sticky sugars too!
- On the board draw pictures representing the ingredients that plants use to make food:
Air + Water + Sunlight + Chlorophyll = Plant Food (Sugars)

Let's Review

- *What are the six plant parts?*
- *What part of the plant is the food kitchen?*

Keep Exploring

- Observe carefully the plant parts of other plants in the classroom and outside.

13. We All Work Together!-K

Name _____ Date _____

Draw a picture of your plant.

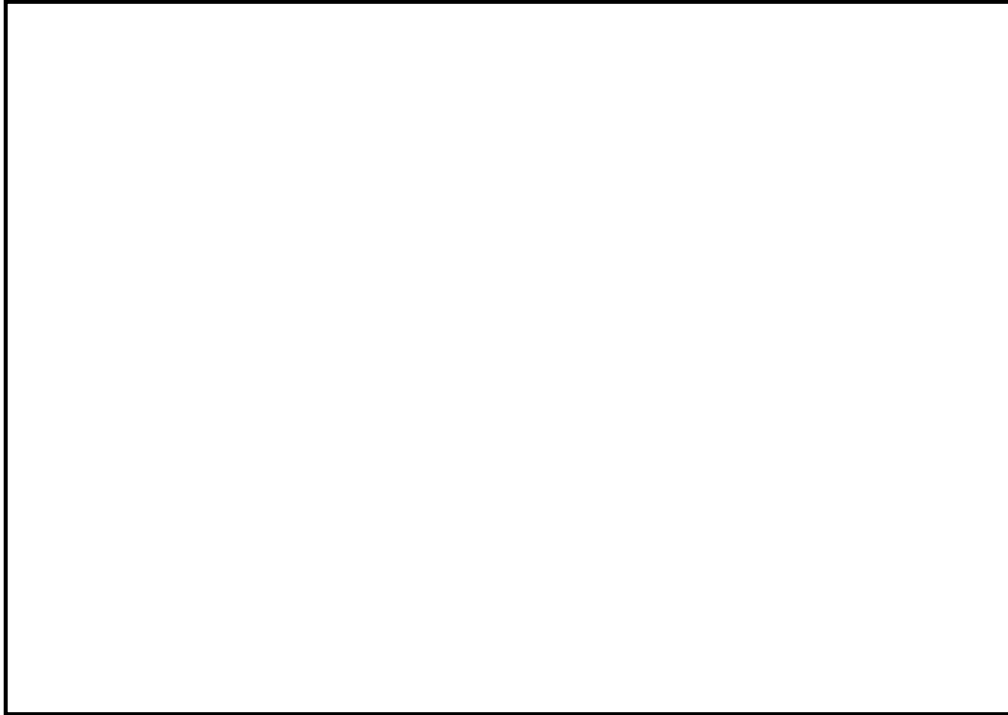

What does the plant with no roots look like after 10 days?

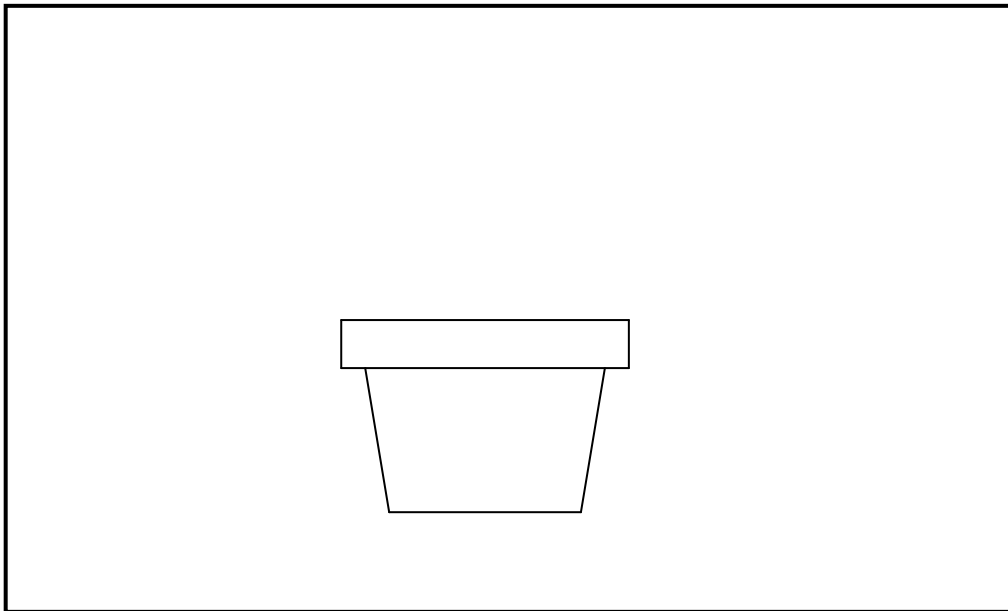

Every Part Has a Job

Roots

- Pull water and minerals from the soil
- Hold the plant in place

Stems

- Carry water and food to the rest of the plant
- Hold up the leaves and flowers

Leaves

- Where plants make their food (photosynthesis)

Flowers

- Where seeds are made
- Attract pollinators

Fruit

- The part of the plant that contains and protects the seeds

Seeds

- The part of the plant that contains the baby plant (embryo) and the food for the embryo to use before photosynthesis starts

Objective: Learn more jobs for plant parts.

- Practice observation skills
- Draw conclusions from experiment results
- Identify basic plant survival needs

Materials

- Magnifying glasses
- 5-6 stems of alstroemeria flowers (most grocery stores have inexpensive bunches of these.) Have one flower for each student and one for yourself.
- Artificial flower such as a lily that shows the flower parts clearly
- Artificial bee (One drawn on and cut out of cardboard will work.)
- 1 large lima bean for each student and several for yourself
- A piece of real fruit that has lots of seeds (same or different from last week's)
- Container for the flowers
- Plant, flower, and seed diagrams (attached)

**Preparation**

- Soak the lima beans overnight
- Cut the alstroemeria stems very short and keep in water. Cut the stems into short pieces (have one for each student).
- On the day of the class, break the flowers off of the stems and put in a container.
- Gather the other materials.

Procedure

During the last class you started learning about roots, stems, and leaves. Today you will learn about the other parts of a plant. First, let's review last week's information and look at what happened with our experiments.

Question: *What happened to your two plants? Do they look different? (The one without the roots should be wilted by now. If not, wait a few more days for this discussion!) What did you learn from this experiment?*

- Have a short discussion on the topic.
- The correct conclusion is that plants need roots to get water from the soil.

Question: Roots have another important job too. Have you ever tried to push over a tree or bush? Let me see if I can push over the plant that has roots. (Gently push on it. Don't pull it out!) How about the wilted one without roots? (That one should be easy to push over.) What is holding up all of the plants? (roots) What would happen if all of the plant roots disappeared and a strong wind came by? (the plants would all fall over) So roots are holding up the plants.

Question: What happened to the celery in the food coloring? What did you learn from the experiment?

- Have another short discussion.
- Stems pull water up through a type of tube. They pull the water that the roots pulled up from the soil up through the rest of the plant.
- Pass out the alstroemeria stems and have the students squeeze the ends for a watery surprise!

Question: Stems are important for another reason too. What would happen to the leaves and flowers on a plant if the stems disappeared? (They would fall on the ground.) Remember, those leaves are important because they are like the kitchens for the plants. That is where the plant makes its own food.

Question: What part of the plant do bees like the best? (flowers)

- Show the artificial flower pointing out the petals and the boy and girl parts in the center.
- Pass around the real flowers and let the students spend some time looking at them, smelling them (they have very little scent) and feeling them. Use the magnifying glasses as well.
- Take your demonstration flower apart and open the small green part on the bottom. This is the ovary and will contain baby seeds. The students love to see these! Go to each table and help the students find the seeds in their flowers.
- Making seeds is the job of the flowers.

Question: As the seeds are growing, they need protection. Do seeds wear clothes? We looked at something last week that was full of seeds. Do you remember what it was?

- Show the fruit and cut it up to show the seeds inside.
- The job of fruit is to protect the seeds as they grow.
- When they finish growing you can plant them and new plants will grow.
- Show the lima bean. Open it up and let the students see the baby plant that is inside.
- Open up a seed for each student and let him or her look at the seeds and baby plants with their magnifying glasses.

That is how all of the plant parts work together!

- *Act it out! You are going to be all of the plant parts and do your jobs so that your plant will grow up to be strong and to make more plants.*
 - *Grow your roots down deep into the ground so that no one can knock you over. (Stomp on the ground and plant feet firmly.)*

- *Pull water and minerals up through your roots making a sound like sucking through a straw. (Lean over and “pull” the water with hands from the toes up the leg.)*
- *The stems pull the water up into the plant. (Keep moving the hands up the legs and body as if pulling the water.)*
- *The stems are holding up the next part. What comes next (leaves)? The stems bring water and minerals to the leaves too. (Spread hands out like leaves.)*
- *The leaves are making something good for the plant. What is it (food)? (Reach hands up to the sun and wave around.)*
- *Next the flowers grow and are very beautiful to attract bees and other pollinators. (Put hands around face and smile.)*
- *A bee comes along and pollinates your flower and something starts to grow inside of the flower (seeds). (Put hands together in a small ball and let it “grow”.)*
- *Fruit grows around the seeds for protection. (Put arms up in a big circle.)*
- *Now your seed is grown and someone comes along and plants it in the soil. (Squat down and curl into a ball.)*
- *This gardener wants you to grow and so gives you water. The sun keeps you warm and air is all around you. Now you have the water, warmth, and air that you need to sprout. (Start to move up out of the ball.)*
- *Now you are above the soil and can grow into a big, healthy plant. (Finish straightening up and reach high into the air waving around like a tree in the wind.)*

So that is how all of the parts of the plant work together!

Let’s Review

- Review the plant parts that are on the board.
- Talk about each plant part’s job.
- *What is your favorite plant part? Why?*

Keep Exploring

- Look for plant parts all around in the school and outside on the grounds.
- Read the [The Tiny Seed](#) by Eric Carle, [From Seed To Plant](#) by Gail Gibbons, [A Seed Grows](#) by Pamela Hickman and Heather Collins or [Jody’s Beans](#) by Malachy Doyle

14. More Plant Part Jobs!-K

Name _____ Date _____

Each part has a job!

Color the fruit red

Color the seeds black

Color the flower yellow

Color the leaves green

Color the stems green

Color the roots brown

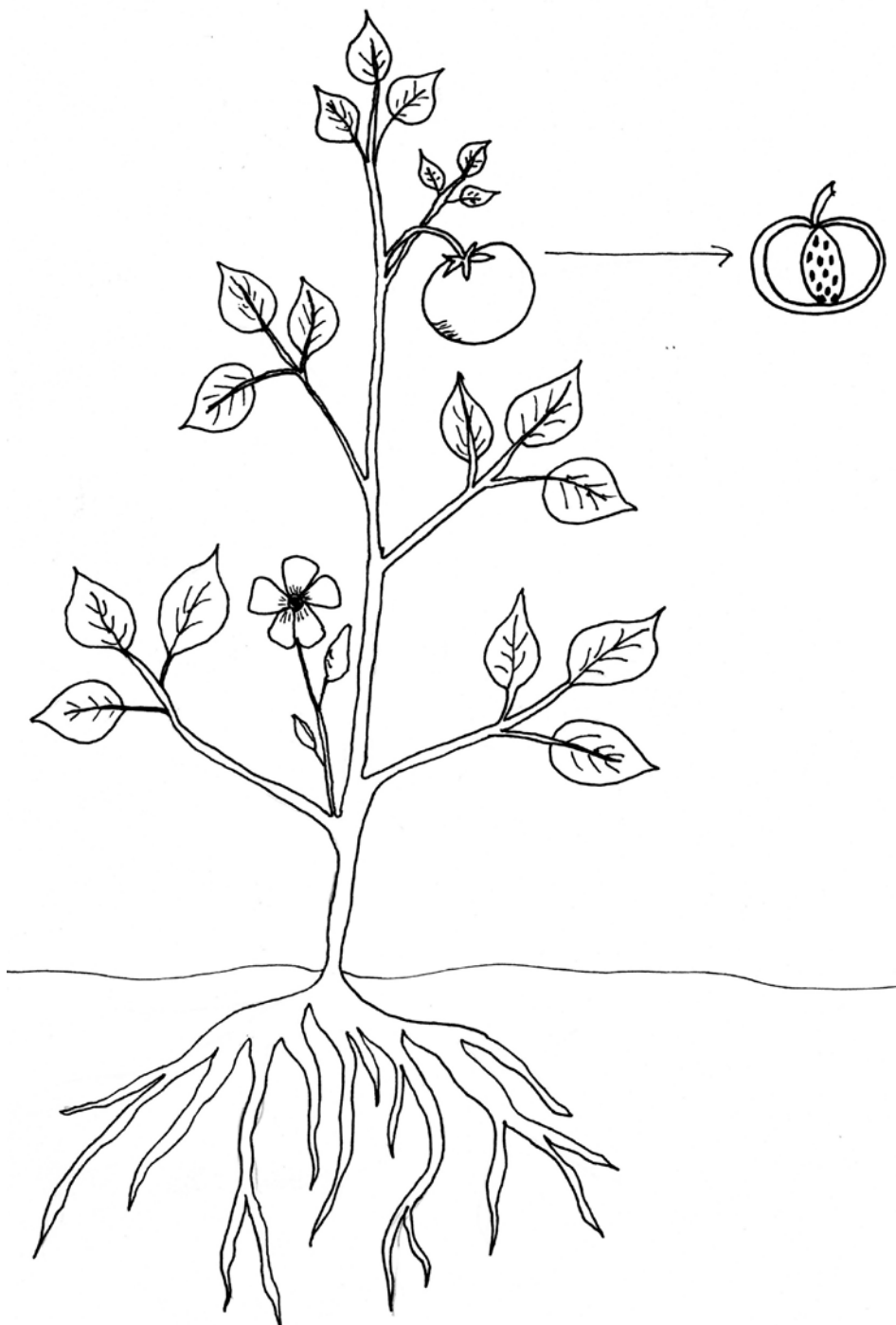

Flower Parts-

1. Petals
2. Stamen
3. Anther
4. Filament
5. Pistil
6. Stigma
7. Style
8. Ovary
9. Ovules

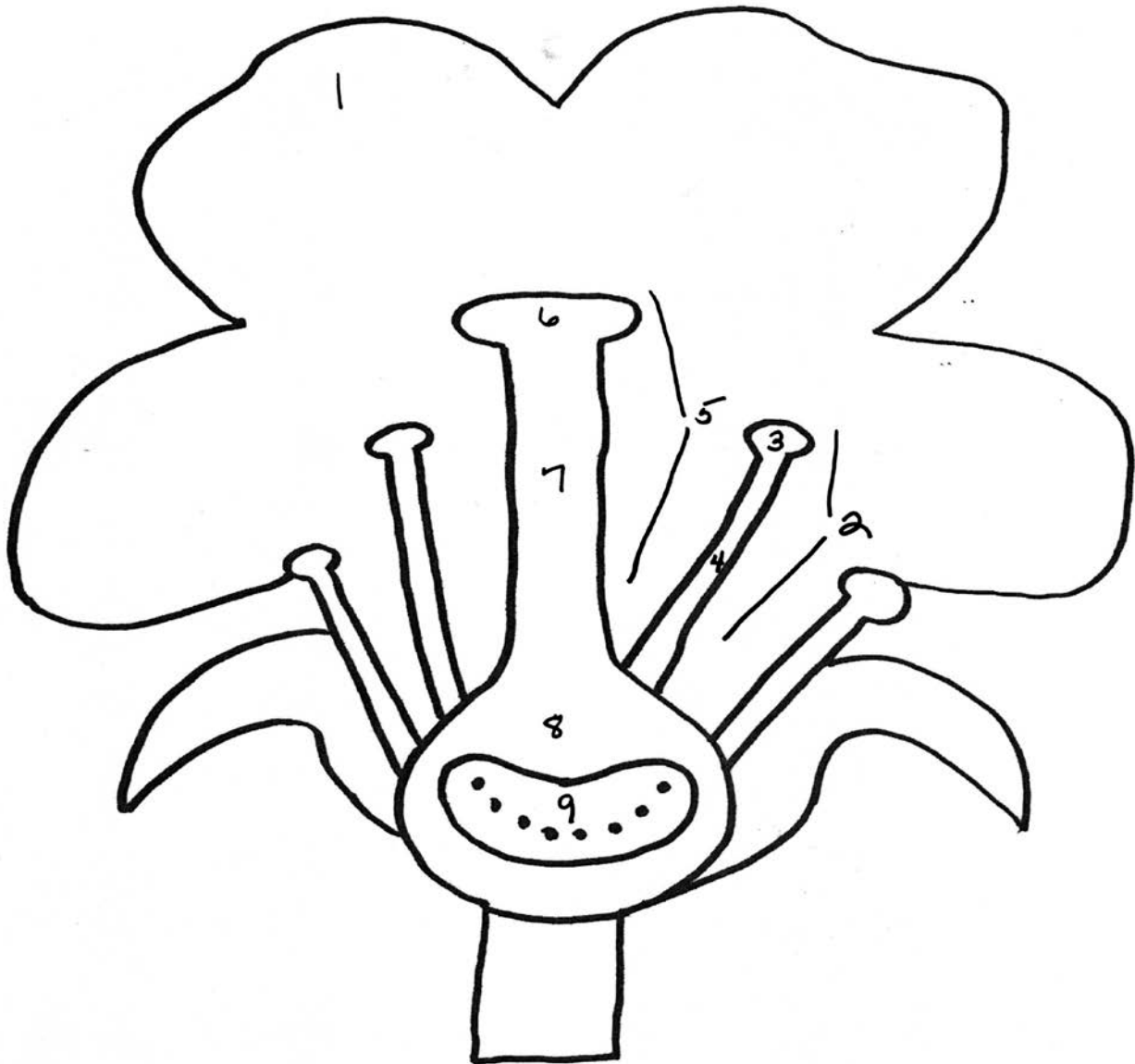

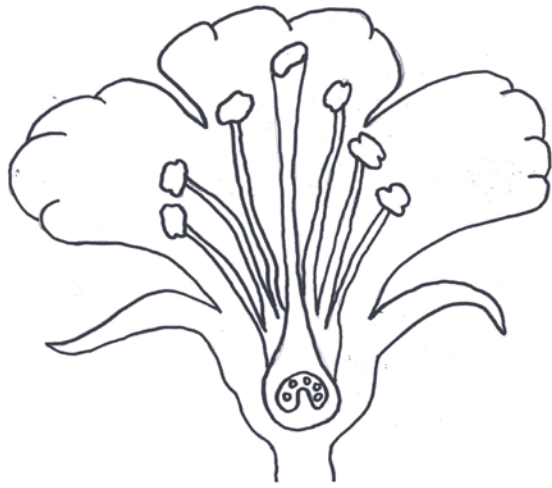

FLOWER

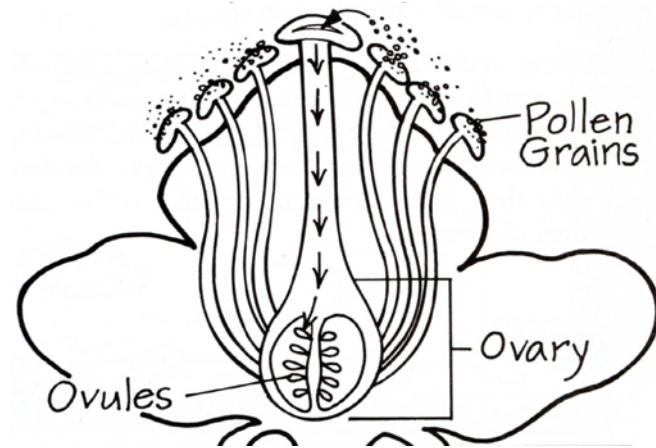

POLLINATION

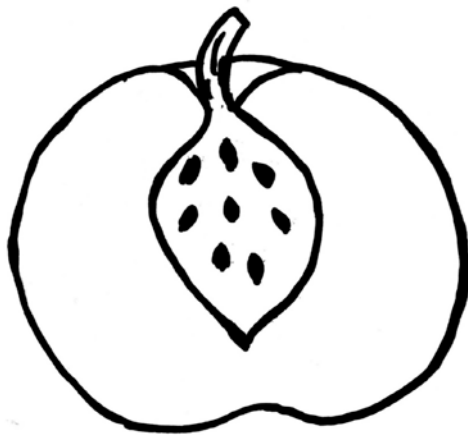

SEEDS!

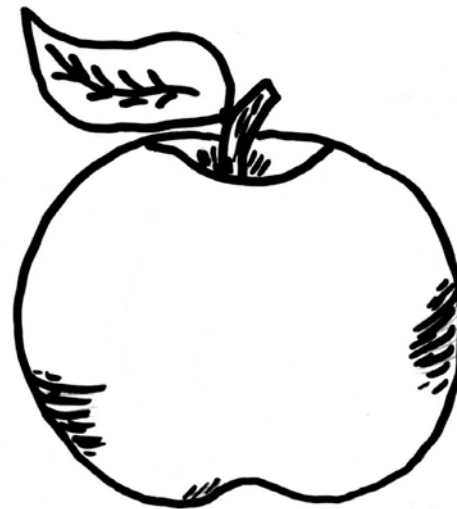

FRUIT!

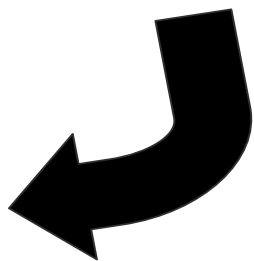

How Pollination Works

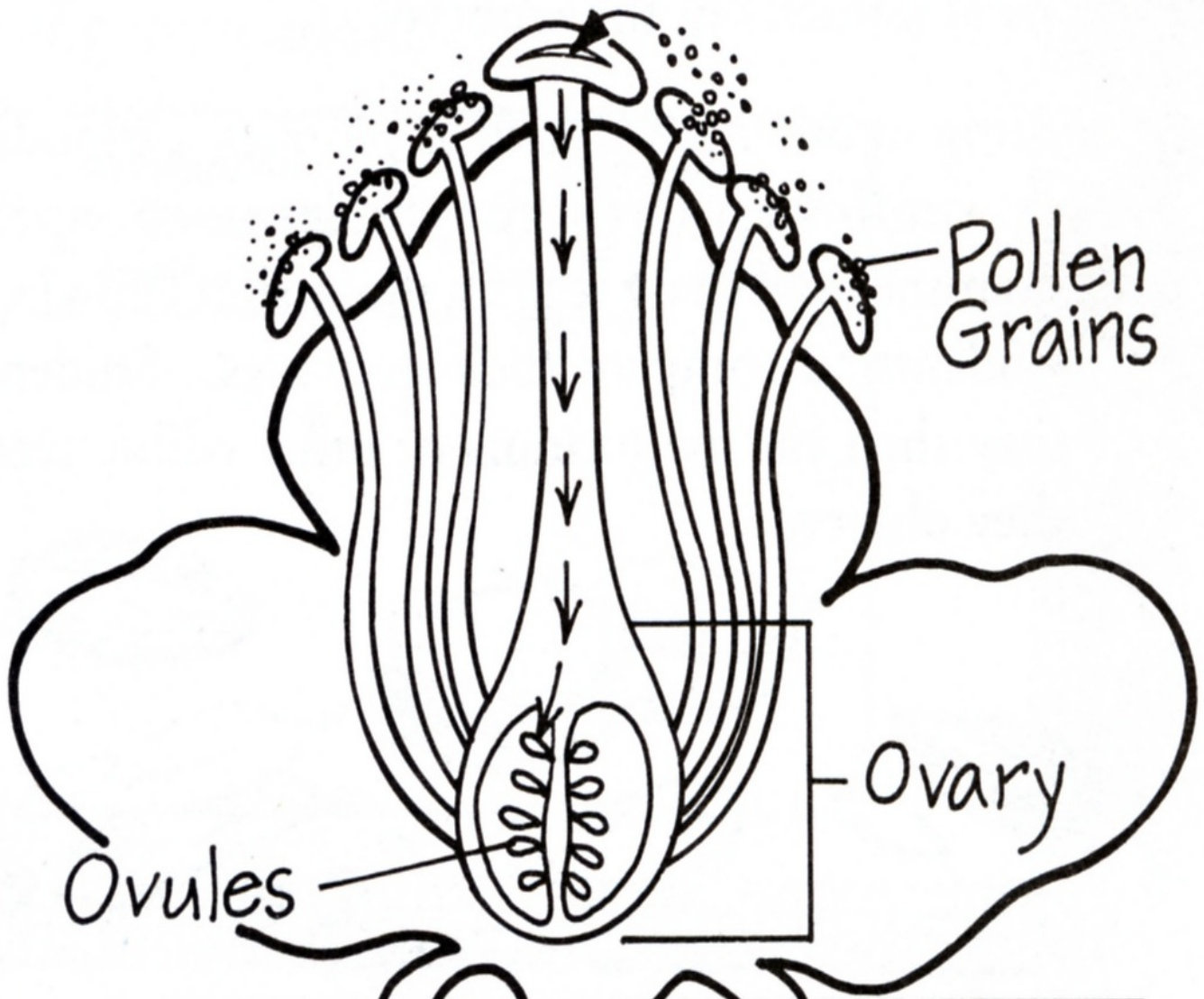

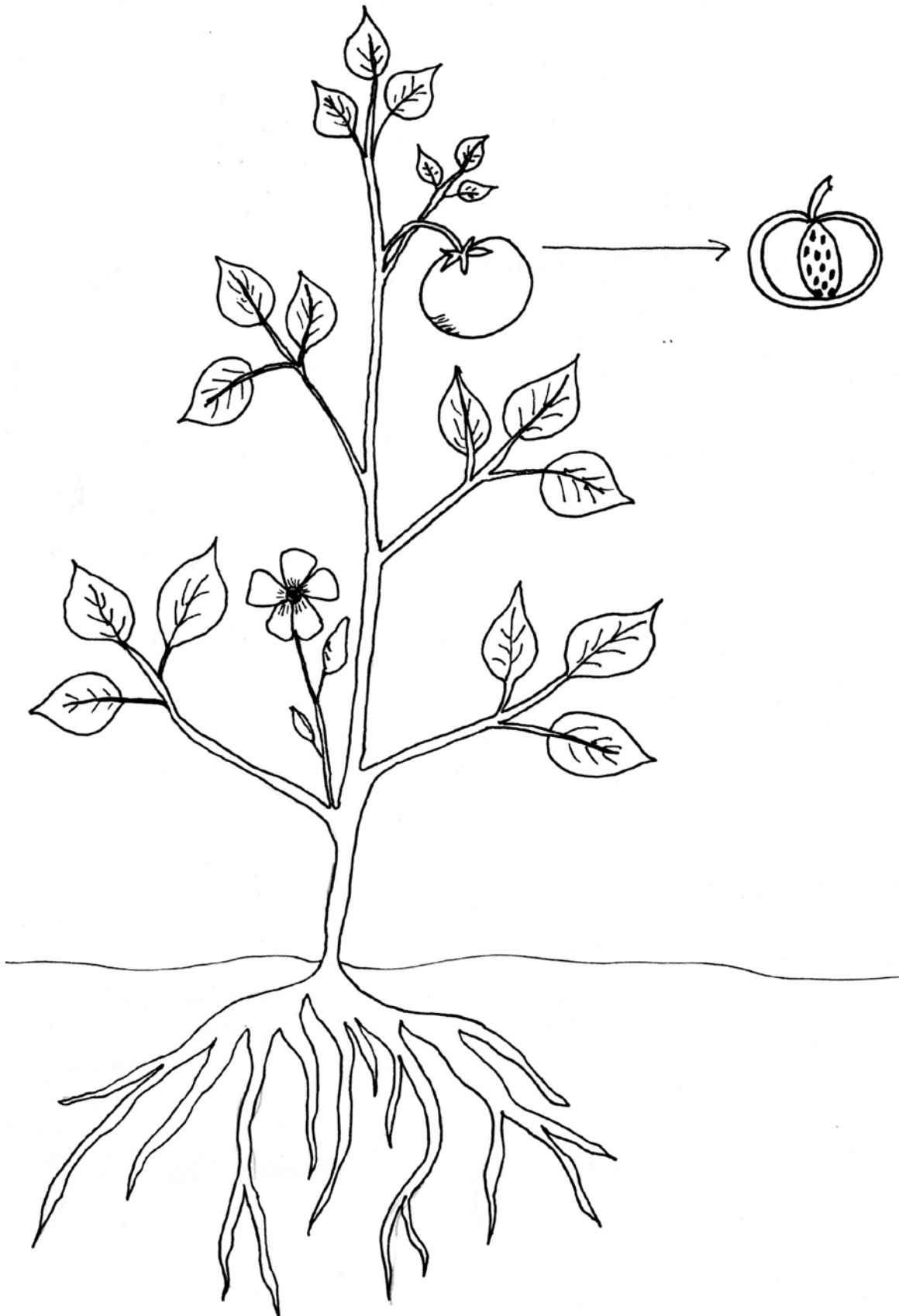

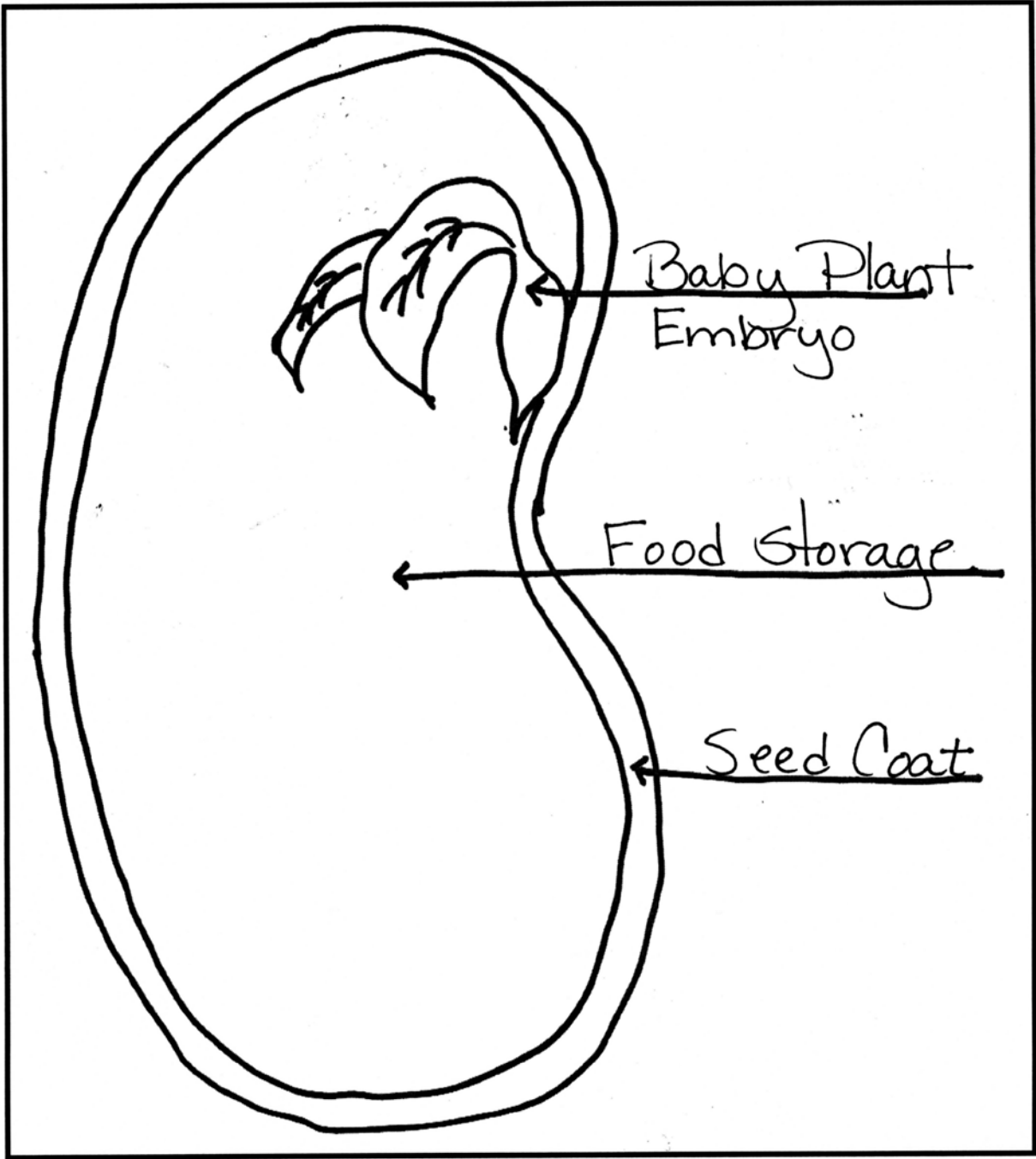

Pollinators







Objective: Set up and use indoor Plant Lab

- Review plant growth needs
- Plant lettuce for studying and for eating
- Learn how to use the Plant Lab

Materials

- Materials and directions for building Plant Lab Light Frame (attached)
- Planting instructions (attached)
- Planting Guide (attached)
- Growing Lettuce Guide (attached)
- 1-2 packages of lettuce seeds. A type of buttercrunch or other looseleaf type works well, or Tom Thumb for small, compact plants. If you use a second package, use a colorful lettuce for variety.
- Small bag of soilless potting mix
- 6 six-inch plastic pots
- 6 plant tags (plastic or popsicle sticks)
- Permanent marker
- Spray bottle
- 2 plastic or aluminum trays that will fit under the lights (approximately 18-24" x 12")
- Clear plastic, such as Saran Wrap, to cover pots
- Several pieces of newspaper
- 8-12 toothpicks

**Preparation**

- Find a place in the classroom, close to an electrical outlet, for the light frame.
- Prepare the materials and build the plant lab light frame. (see instructions)
- Mark plant tags with numbers 1-6 (group numbers plus an extra) and the date of the lesson.
- Cut out small pieces of newspaper to cover holes on the pot bottoms. (2 layers)
- Clear an area for the planting activity and put all of the supplies there (soil in large container, seeds, containers, plant tags, spray bottle with water).
- Add water to the soil so that it is moist, but not soggy. Let it sit for several hours.
- Copy journal pages.

Procedure

We are in the middle of winter, but we can still grow lots of plants right here in the classroom. Today we are going to set up an indoor plant lab. You'll be able to grow plants for experiments and for eating!

Question: *What are some of the things that our plants will need so that they can grow strong and healthy?*

- Take answers from the students. Prompt the students if necessary to get the answers water, light, warmth, air, and space.

We are going to grow our own lettuce for a salad party in a few months! In the fall, you learned how to plant seeds outdoors. Indoor planting is the same except that we use containers and artificial light.

- Show the plant lab light frame to the students. Plug it in and hear the oohs and ahs!
- Demonstrate, using the planting supplies, how to plant seeds in the containers. Repeat the demonstration with assistance from some of the students.
- Each group (5) will plant their own 6" pot with seeds. Divide up the planting steps so that each student in the group has a job. Assist with each group.
- Explain the journal pages so that the students who are not planting can stay at their tables and work on their journal pages.
- Put the plant tags in the containers, insert toothpicks, cover the containers with the clear plastic, and place them under the lights.
- Read the plant care instructions to the class and hang the instructions by the plant lab.
- Have the lights about 1-2 inches above the soil.
- As the plants grow, move the lights up to keep them 2-3 inches above the leaves.
- Spray the soil so that the seeds do not dry out as they are sprouting, but do not keep the soil soggy.
- Remove the plastic after the seedlings are about ½ tall so that they will not mold.

Question: *What do you think will happen to your seeds in the pots? We'll watch them carefully over the next few weeks!*

Let's Review

- *What type of seeds did you plant?*
- *How are we going to take care of these seeds?*

Keep Exploring

- Plant some other types of plants under the lights. See the attached plant guide for ideas.
- Make seed cups so that the students can see what different type of seeds look like as they sprout and grow. Use a variety of seeds that are different from the ones used in the cups in Lesson #2.

Seed Cups

Materials: Paper towel, large clear plastic cup, 3-5 different types of seeds

Directions:

1. Fold a paper towel to fit the height of the cup.
2. Put the paper towel in a clear plastic cup and moisten.
3. Put seeds between the cup and the towel so that they can be seen.
4. Place the seeds half way down the cup.
5. Write the name of the seeds on the lower part of the cup below the seeds.
6. Put the cups in a warm part of the room. Put them in a bright area, but not in direct sunlight.
7. Keep the paper towel moist, but not soggy. Do not let it dry out.

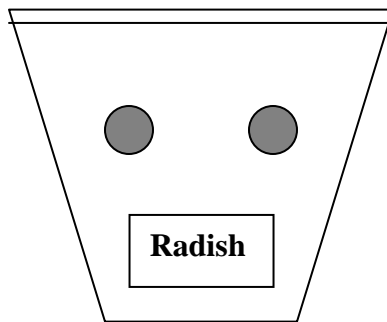

15. Let's Build Our Plant Lab-K

Name _____ Date _____

What will your lettuce plants look like?

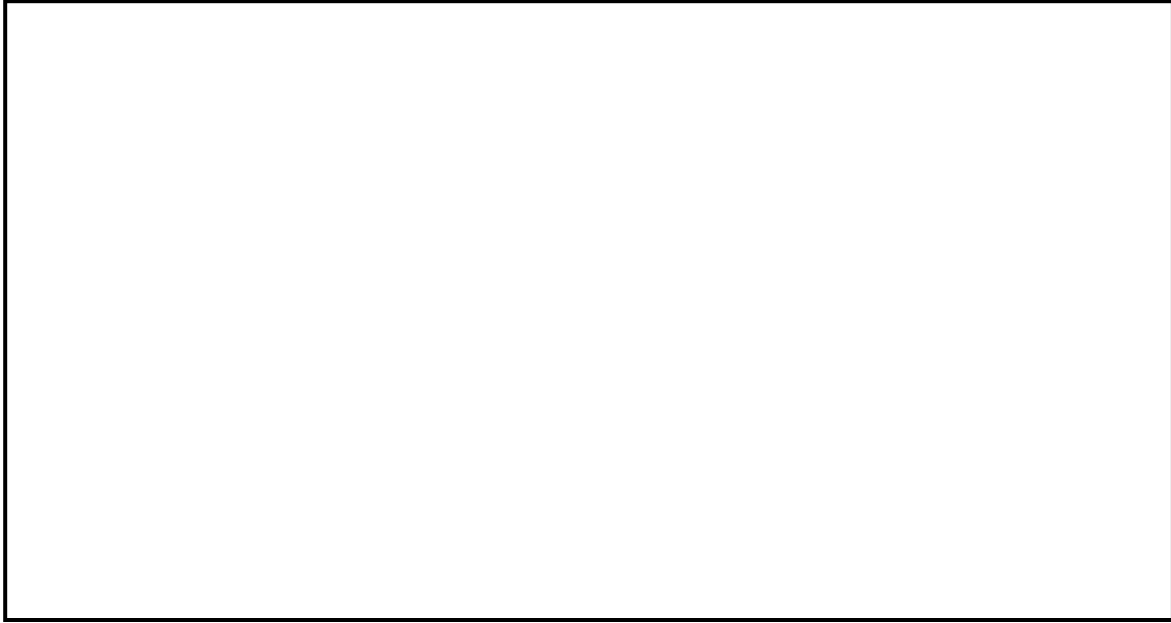

Draw a picture of a yummy salad.

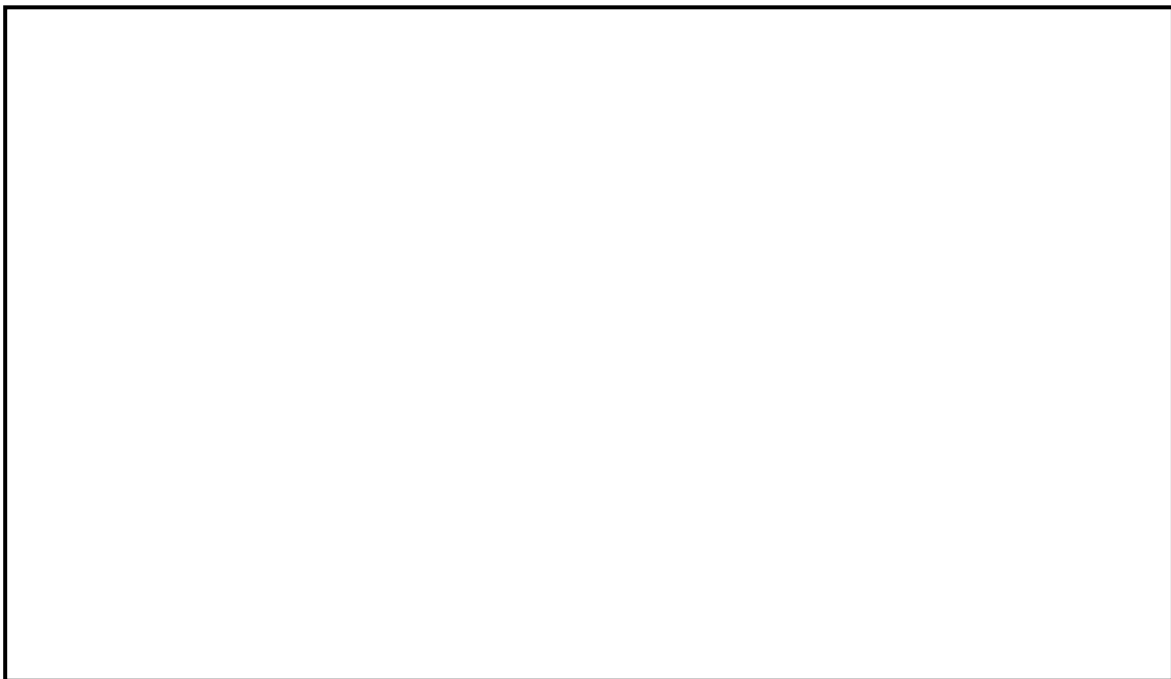

Growing Lettuce

- Check the trays everyday and keep the soil surface moist as the seeds sprout.
- When the plants are several inches tall, switch to putting water in the trays for the plants to take up. Keep the soil moist, but not soggy.
- Move the light up as needed to keep it about 2-4 inches above the plants.
- Thin out the plants in each pot to four when the plants are about 1 ½ inch tall. The best way is to use scissors to cut off the extras at the soil line, rather than pulling them out.

Lettuce **\$1.59**
Red Sails Net Wt. 2g



Excellent Flavor

ALL AMERICA SELECTIONS WINNER

MOUNTAIN VALLEY SEEDS
SALT LAKE CITY, UTAH 84104

Lettuce Mesclun
Gourmet Baby Greens **\$2.39**
Lactuca sativa 1 gram



21-58 days
Cool season crop - plant early spring or late summer

HEIRLOOM
Enjoy gourmet greens without paying a gourmet price!
Our custom mix of lettuces for baby greens has beautiful colors, rich flavors and diverse textures.

ORGANIC CERTIFIED

Botanical Interests

Lettuce **\$1.49**
Buttercrunch Net Wt. 2g



Crisp, Juicy Leaves

MOUNTAIN VALLEY SEEDS
SALT LAKE CITY, UTAH 84104

Light Frame Instructions

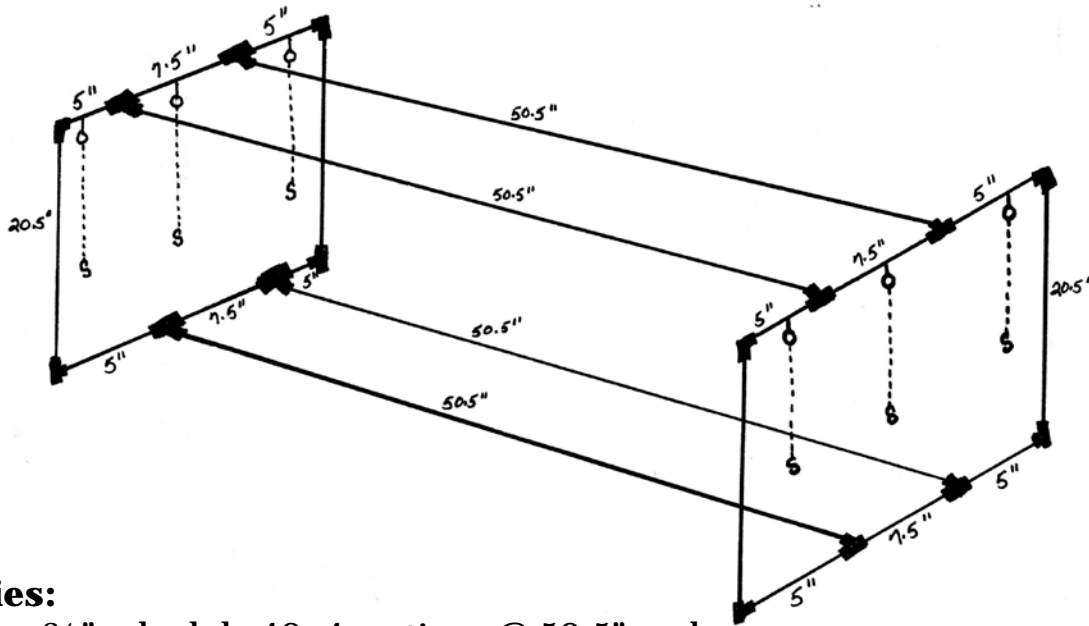

Supplies:

PVC Pipe $\frac{3}{4}$ " schedule 40: 4 sections @ 50.5" each
4 sections @ 20.5" each
4 sections @ 7.5" each (2 with holes and eyebolts)
8 sections @ 5" each (4 with holes and eyebolts)

PVC connectors

4 elbow connectors
12 T connectors

Hardware

6 eyebolts with nuts/ 2.5
6 chains about 18" (should be in the box with the shop lights)
6 S hooks (should also be in the box)
6 large, heavy duty paper clips or 6 more S hooks

Lights

3 shop lights 4' long
6-outlet power strip
6 regular cool 40 watt florescent bulbs or the warmer florescent bulbs for kitchen and bathroom

Tools

PVC cutter or hacksaw
Electric drill and drill bit for PVC

Directions:

- Cut the PVC segments.
- Drill holes for the eyebolts in the centers of 4 of the 5” and 2 of the 7.5” segments. Insert the eyebolts and nuts into the holes.
- Attach connectors to the PVC segments.
- Assemble the frame as shown. It is easier to assemble the end pieces first (the short lengths) and then connect these to the long segments. Make sure that the eyebolts face down when assembled.
- Install the fluorescent tubes into the shop light fixtures. Test that the lights work before hanging them up. If they do not turn on, try taking them out and reinstalling so that they click in correctly.
- Attach the chains to the light fixtures with the large paper clips or extra S hooks.
- Hang the fixtures on the chains with the S hooks.
- Plug the light fixture electrical cords into the power strip.
- Plug the power strip cord into the timer and plug the timer into an electrical outlet. Turn the timer to “on”.
- If the lights do not come on, unplug the main cord and press the GFI “reset” button or check to make sure that the switch on the power cord is on.
- Adjust the timer to allow 16 hours of light a day.
- Put the trays on the bottom of the frames.

Notes:

- This is easier to assemble than it may seem. Give it a try. It’s worth it!
- The warmer bulbs work a bit better, but the cool ones are generally less expensive and work adequately for the classroom projects.
- Keep the lights about 1-2” from the seedlings. As the plants get larger, you can keep them 2-3 inches above the plants. Move the lights up and down by adjusting the length of the chain. If you need a longer chain, add heavy duty paper clips.
- Plants need a period of darkness to complete the photosynthesis cycle and to grow correctly, so do use the timer.
- Do not let the plants stand in water.
- Light intensity is greater at the center of the fluorescent tubes than at the ends. Rotate the plants every couple of weeks so that they all get adequate light.

Planting Guide

Crop	Days to germination	Weeks to maturity	Plants per 6" pot	Plants per 4" pot	Seed planting depth	Approximate yield	Notes
Beans	4-8	8-9	1-2	—	1-1 ½"	6-10 per plant	Use bush types
Beets	5-12	9-12	4-5	2	½"	1-1 ½" size	Soak seeds 24 hrs. in water before planting
Carrots	8-16	10-11	4-6	—	½"	2" long	Use small varieties
Pak Choy	5-8	9-12	1	—	½"	2 cuttings	
Cucumbers	5-10	9	1	—	½-1"	1-3 6" cucumbers per plant	Use bush types
Lettuce	4-8	7-8	4	1-2	¼"	4 small plants	Try Tom Thumb, Buttercrunch, Ruby, Salad Bowl
Onion tops	7-14	6-8	12	6	½"	Continuous cuttings	Won't grow large bulbs
Parsley	10-20	8-10	4-6	1-2	¼ to ½"	Continuous cuttings	Soak seeds 24 hrs. in water before planting
Peas	5-10	8-10	1-2	—	2"	4-6 pods per plant	Try Little Marvel, Laxton's Progress
Peppers	8-14	9-12	1	—	¼-1/2"	2 small fruits per plant	
Radishes	3-5	4-5	6-8	3	¼-1/2"	½-1" size	
Strawberries (Alpine)	20	12+	2	1	1/8"	4-8 small berries	
Tomatoes	6-10	10-12+	1-2	—	¼-1/2"	6-15 small fruits per plant	Use small varieties such as Tiny Tim, Patio Hybrid, and Red robin
Swiss Chard	7-14	8-10	1-2	—	½"	Continuous cuttings	

Planting Seeds!

1. Moisten the soil ahead of time. (Damp like a wrung out sponge.)
2. Choose your seeds.
3. Choose your containers
4. Fill the soil almost to the top.
5. Hold the container about 2 inches above the table and drop it gently several times to settle the soil.
6. Make a hole in the soil that is about 3 times deeper than the seed is wide.
7. Drop the seed into the hole. (Drop in several extra. You can thin them out later if they all germinate.)
8. Cover the seed with soil and press down lightly.
9. Water gently.
10. Mark the plant label and put in the container.
11. Put the containers in a tray and cover with plastic wrap. Keep the wrap off of the soil with toothpicks or the plant labels.
12. Place the containers in trays about 2 inches from the lights.
13. Follow the directions for growing lettuce (attached).

Objective: Use experiments to test if plants really do need leaves, light, and water to grow.

- Make hypotheses
- Set up experiments
- Collect data
- Draw conclusions from experiments

Materials

- 1 dead plant in a pot
- 4 small live plants (same type and size plants and pots)
- 1 paper lunch bag
- Journal Pages (attached)
- Scissors or clippers
- 4 index cards



Preparation

- Collect materials
- Print out record forms

Procedure

Pass around the dead plant for close observation.

Question: *What do you think happened to this plant?*

- Have a short discussion about what plants need that this plant may not have received.
- *Let's test out some of your ideas. Remember that you are all plant scientists or botanists.*

Question: *Why do plants need light? (To make food for the plant) What would happen if our plants did not get any light for one day? How about if they did not get any light for a lot of days?*

- Have a short discussion.

Question: *How do you think that we can find out?*

- Get some ideas from the students. They may need some prompting!
- Discuss the experiment that you have for them.

Repeat the same questions followed by discussions about plants' need for water. Discuss the additional experiments that they will set up.

Experiment #1: *Do plants really need light to grow well?*

- Put the two of the plants in a place where they will get some direct light such as the light frame, if there is space, or a window. Do not put them in the plant lab light frame

if you already have small seedlings as you would need to raise the lights too high and your seedlings would get too stretched out.

- Put the brown paper bag over one of the plants.
- Label the plants using the index cards:
 - Plant #1: With Light
 - Plant #2: Without Light (put the label on the bag)
- Let the students know that you will water the plants with the same amount of water so that the only difference in care is the amount of light that the plants get.

Experiment 2: Do plants really need water to grow well?

- Use the last two plants.
- Label:
 - Plant #1: With Water
 - Plant #2: Without Water
- Test with your fingers that the plants start out with about the same amount of moisture.
- Water plant #1 as you do the others.
- Do not water plant #2.
- Put the plants next to the ones in Experiment #1.

Question: Let's take a look at all of the plants in these experiments. For what are we testing in each one? What do you think will happen to each of these plants?

- Across the top of the board, write the plant labels.
- Discuss each one, clarifying the differences and similarities with the care of each one.
- Write the students' predictions on the board under the labels (for example, under "Plant #2: No Water", you might write "the plant will dry up".)
- On their journal report pages, the students will keep track of the growth of the plants over the next 4 weeks.
- Review the progress of the plants at least once a week. Let them spend some time really looking at and feeling the plants.
- As results become obvious, query the students about the similarities and differences between their predictions and the actual results. What did they discover?

Let's Review

- *What are we trying to find out with our experiments?*
- *How are we going to keep a record of what happens to our plants? (Show and explain the journal record pages.)*

Keep Exploring

- Set up more experiments with different variables such as:
 - Use different types of plants with the same experiments.
 - Keep one plant in the refrigerator and one out.
- Read [Fran's Flower](#) by Lisa Bruce or [The Carrot Seed](#) by Ruth Krauss

Curricula funding provided by The Humana Foundation for the Salt Lake City School District

16. Really, That's What We Need!-K

Name _____ Date _____

Do plants need **light**? How do your plants look **today**? Draw with colors.

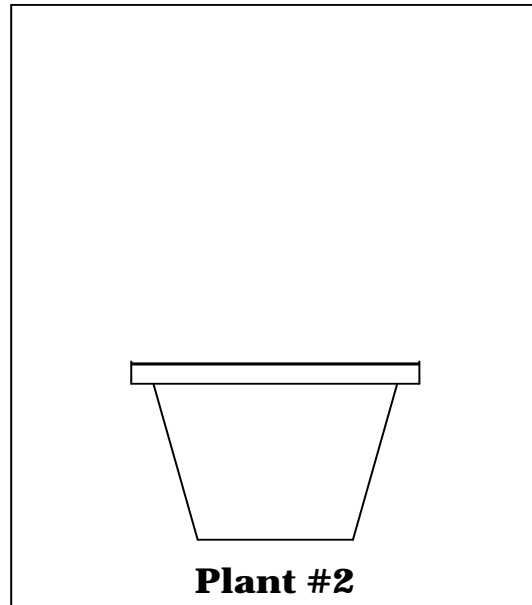
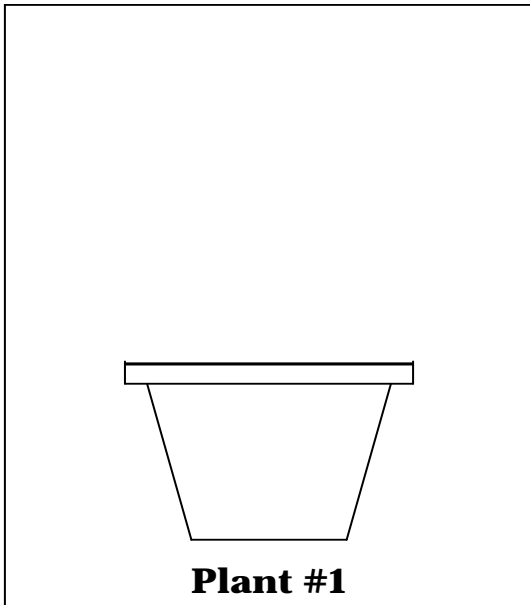

How do your plants look after **4 weeks**?

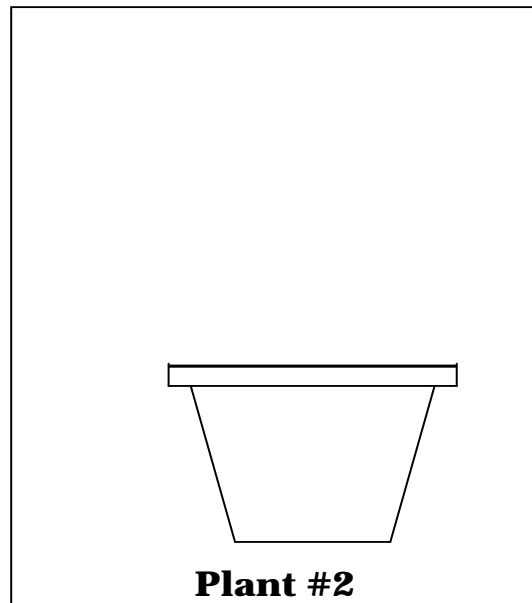
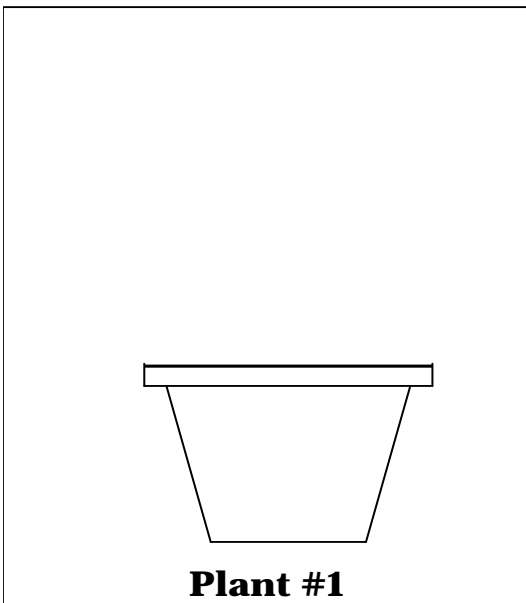

Do plants need light to grow? _____

Do your plants need **water**? How do your plants look **today**? Draw with colors.

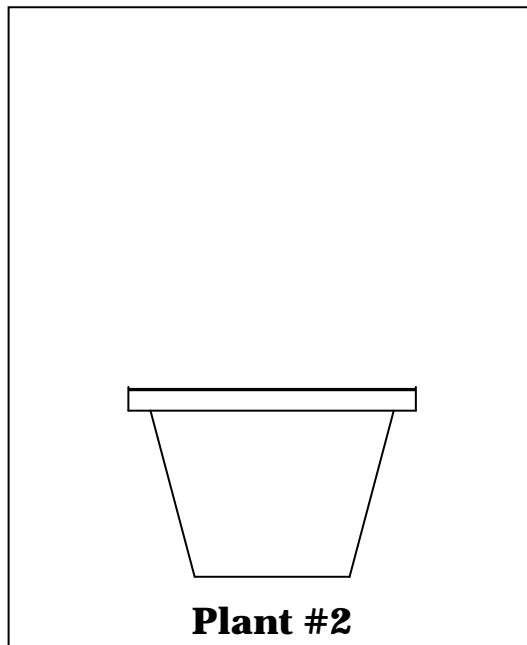
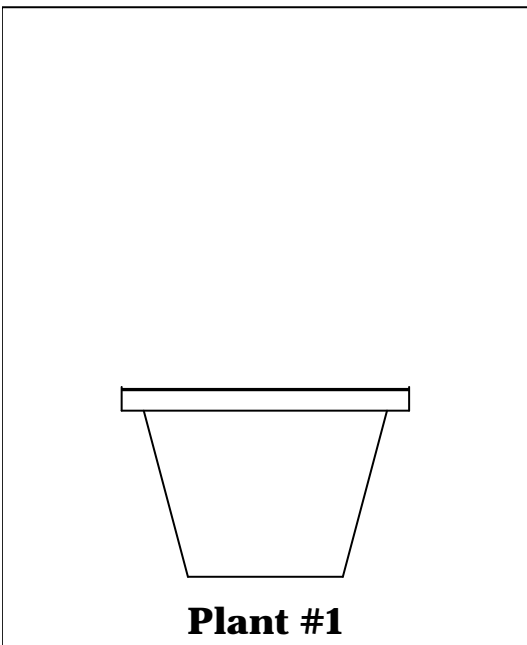

How do your plants look after **4 weeks**?

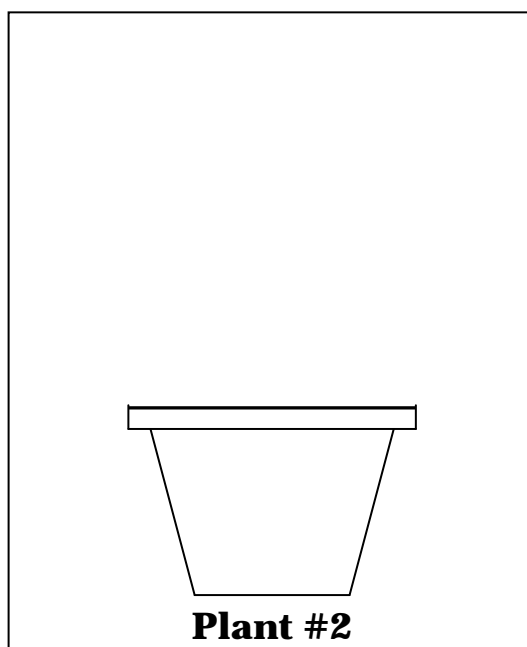
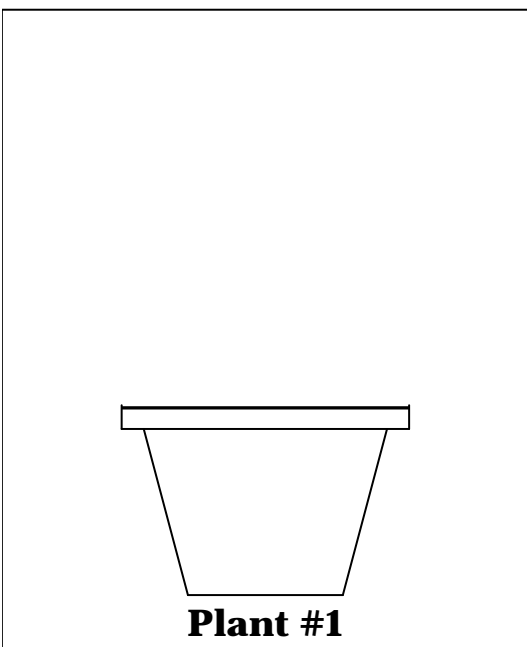

Do plants need water to grow? _____

Objective: Discover the effect of microwaves on seeds

- Sharpen data gathering skills.
- Refine the skills involved in using the scientific method and experiments

Materials

- A few soft green leaves such as spinach or lettuce
- Microwavable plate
- Empty plastic egg carton
- Potting soil (enough to fill each section of the egg carton)
- Package of radish seeds
- Microwave oven (perhaps a field trip to the teacher's lounge or school cafeteria?)
- Large paper with the class record sheet enlarged or drawn on (attached)
- A paper towel

**Preparation**

- Draw or enlarge class record sheet and hang up close to where the experiment will be.
- Fill each section of the egg carton with damp soil.
- Mark the front of each section of cups with the numbers 0,5,10,20,40,80.

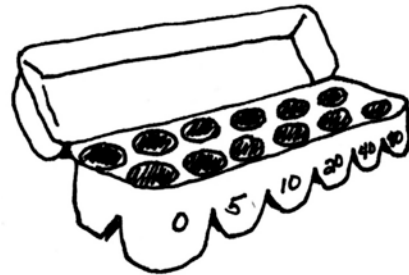
**Procedure**

Question: Let's take a look at seeds again. Seeds have three main parts. What are these?

- Draw a diagram of a seed on the board (see Lesson #14).
- Discuss the parts of the seed with special emphasis on the baby plant and how that is the part that grows up out of the soil into a grown up plant.

Question: We know that seeds need three things in order for the baby plant to germinate (sprout). What are these three things? (water, warmth, and air) What if the seed becomes very hot? I wonder if the baby plant would still grow.

- Take some thoughts from the students about this.

Question: How could we test for this?

- Again, have a discussion to discover what ideas the students come up with.
- After some deliberation, guide the conversation to microwave ovens and how things can become very hot in one.
- Demonstrate with the leaves. Pass around the leaves for observation, then microwave the leaves for 10-15 seconds and let the students observe the results.

- *We could test out our question about heat and seeds very quickly in a microwave. Together set up a good experiment.*

Setting up an experiment step by step:

- *What are we trying to discover? What do we want to know?*
 - Will seeds grow after they have been microwaved?
- *How are we going to do this?*
 - Show the students how you plan to set up the experiment.
- *What do you think will happen to the seeds? Will all, some, or none of them sprout?*
 - Write predictions for each cup of seeds on the class report sheet.
- *How will we keep track of what happens?*
 - Get some ideas.
 - Point out the report sheet and show them where you will report results. They have used record keeping methods in other lessons. This one adds the details of date and time. Observe regularly and draw simple pictures of what happens in the cups. Many will not sprout.

Let's Investigate!

- Demonstrate the planting procedure by planting two seeds in each of the two cups labeled 0.
- Place four seeds on the plate, cover with the paper towel, and microwave for 5 seconds.
- Plant two seeds in each cup labeled 5.
- Microwave the next seeds for 10 seconds and plant in the cups labeled 10.
- Continue with the same procedure, increasing the times, until all of the cups contain seeds. Have the students help with the process where they can.
- Water each section equally with a small amount of water.
- Keep the egg carton in a sunny window or under the grow lights.
- Keep the soil moist, but not wet by watering carefully when the soil begins to dry out.
- Observe the seeds over the next few weeks, making notations on the class report sheet when any of the seeds sprout and grow.

Let's Review

- *For what are we testing in this experiment?*
- *What thing is different in each section of the egg carton? (amount of time in microwave)*

Keep Exploring

- Try different types of seeds with the same experiment.
- Try planting kinds of seeds, then putting the cartons in the freezer. Bring the cartons out after a several weeks to see if the seeds will germinate.

17. Yikes! It's Hot In Here-K

Name _____ Date _____

This is a radish seed with the **baby plant** inside.
Color the plant green and the rest of the seed brown.

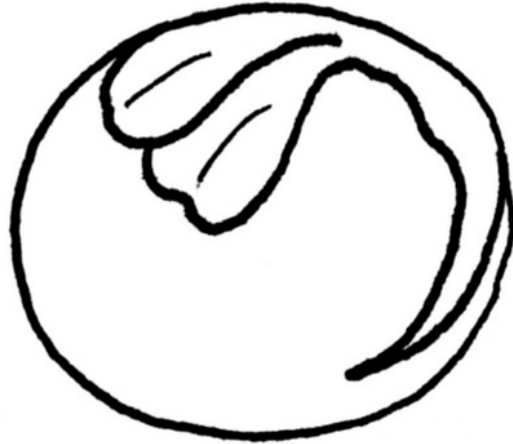

This is a radish **sprout**.
It is the baby plant growing up out of the ground. Color it green.

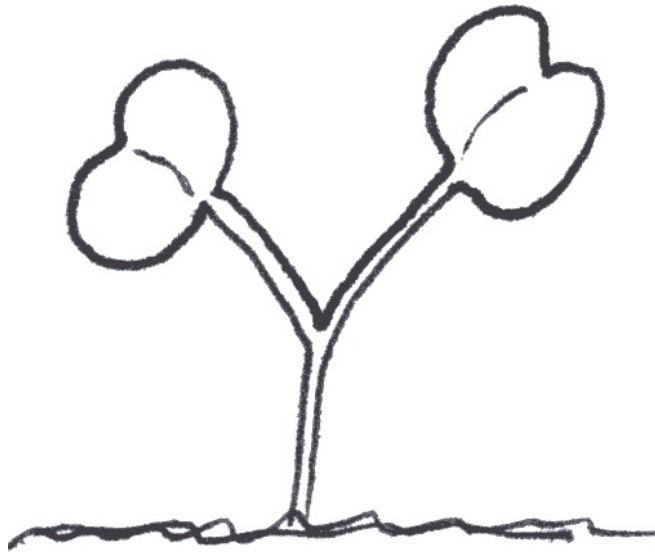

Seeds and Heat

Let's observe what happens to our seeds. Write down your predictions, then draw and write about what happens in each cup over the next few weeks.

Cup #	Prediction (What will happen?)	Date: Time:	Date: Time:	Date: Time:	Date: Time:	Date: Time:
1						
2						
3						
4						
5						
6						

Objective: Learn that plants can be propagated from plant parts other than seeds.

- Reinforce Scientific Method practices
- Use a new data collecting method

Materials

*Note when purchasing vegetables for this lesson: Use organically grown vegetables as some sold in grocery stores use a sprout inhibiting substance that will affect your results.

- 1 sweet potato with roots or small buds
- 2 stems of small ivy. Make sure that the stems have at least 3-4 sets of leaves. Mint also works very well if you can locate a mint plant in a nursery or grocery store. Pre-cut mint at the grocery store often will not work.
- Glass or plastic container to fit sweet potato
- Small container for the ivy or mint stem
- 3-4 toothpicks
- Class data chart for reporting results (attached)
- Large piece of paper for chart (Try to hang it close to the experiments.)
- Camera

Preparation

- Gather materials
- Draw class chart on paper



Procedure

Question: *What part of the plant do we use to make new plants? (seeds) I wonder if there are any other ways to start new plants.*

- Have a short discussion about the topic.
- *We can propagate plants from leaves, roots, and stems also. Not all plants are propagated in the same way.*
- *Let's see if this way of making new plants really works!*

Questions for Experiment #1:

- *What is this vegetable? (sweet potato) What part of the plant is it? (root) Do you think that different plant parts will grow out of it? Let's try!*

Setting up Experiment 1:

- Stick the four toothpicks about ½ way down the potato.
- Put the sweet potato in a glass container with half of the potato



submerged in water. Leave at least one inch on the bottom for root growth.

- Refill the water when necessary.
- Put the sweet potato in a dark place until the roots and leaves start to sprout and then move it to a light area. Have the students keep checking the progress until they can spot the sprouts.

Questions for Experiment #2:

- Pass around the ivy or mint stem that will not be used. Tell the students to rub the leaves gently and smell it.
- *What is this? What part of the plant is it? (stem and leaves)*
- *We will try to grow some new plant parts from this ivy (or mint) also. What do you think will happen?*
- Have the students try to figure out how to set up this experiment. Prompt them to remember that the other experiments were set up so that the plant parts get water and light. The ivy and mint will need this too.

Setting up Experiment #2:

- Carefully remove the bottom set of leaves from the stems.
- Cut the stem $\frac{1}{4}$ inch below the area where the leaves were. This area is called the node.
- Put the stem in a container and fill in water to cover the node area.
- Set in a light area and refill water when necessary.

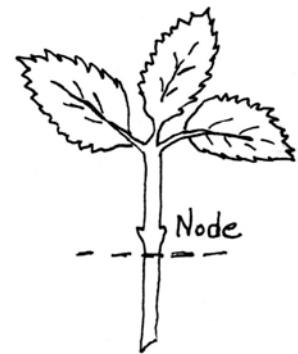

Keeping track of data:

- *We need to keep track of what happens to our plant parts. We'll do this on our class chart.*
- Hang up the chart and fill in the first two columns. Add a picture of the vegetable.
- Explain that they will be taking pictures of the plants as they grow to watch their progress.
- They will add the pictures on a regular schedule and make sure to date them.
- Add more columns to the chart if needed.
- They will figure out if a new part of the plant starts to grow and add that information to the last column of the chart.

Let's Review

- *What parts of a plant did we use for our experiments? Do you think that other plant parts will grow?*

Keep Exploring

- Find out how to propagate other plants from plant parts. Experiment with some of the many plants and procedures. You can create a roomful of plants!

Curricula funding provided by The Humana Foundation for the Salt Lake City School District

18. Plants From Parts-K

Name _____ Date _____

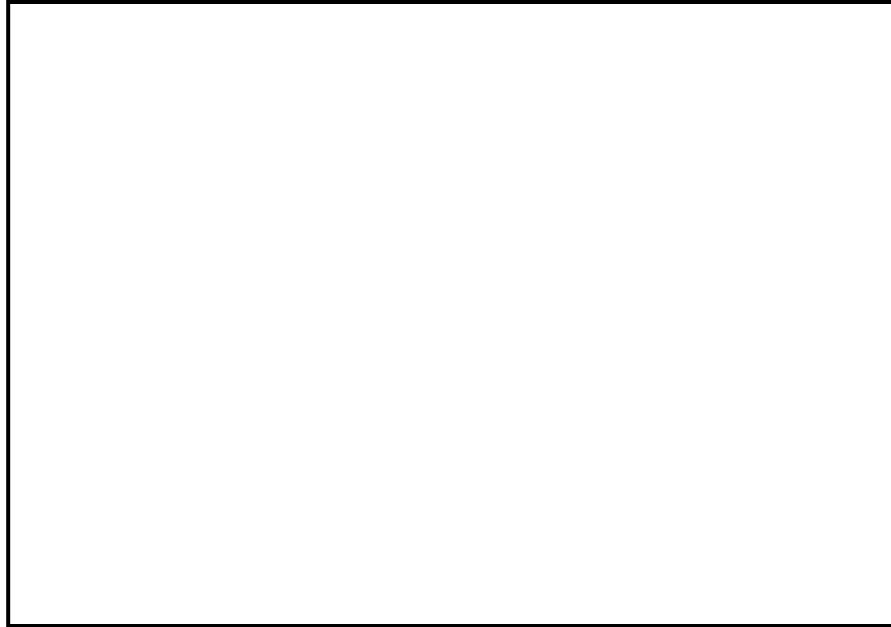

Draw your sweet potato:

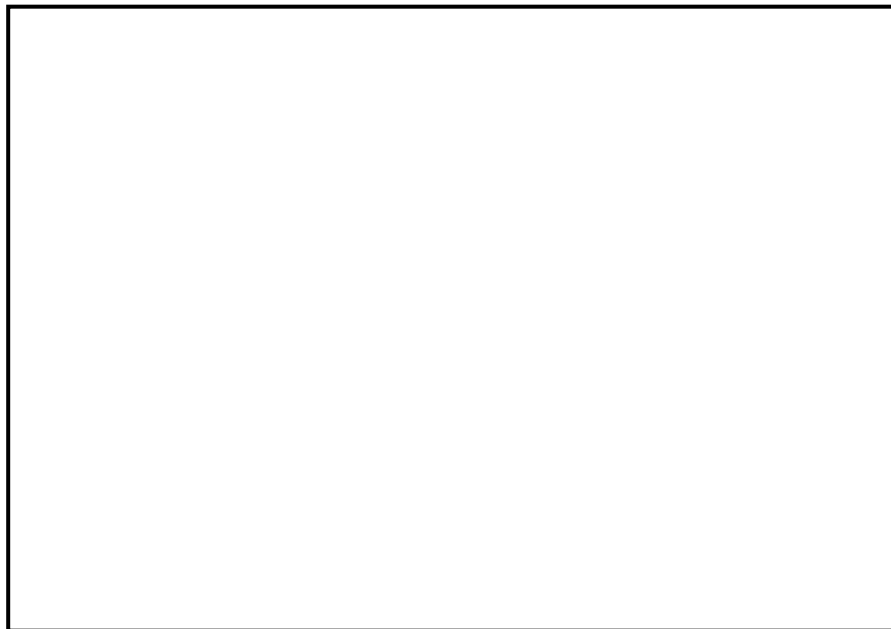

Draw your sweet potato in 4 weeks:



Is it different? _____

What are we growing?	What plant part is it?	What new plant part might grow?	How do our plants grow?					What new plant parts did grow?
			Date	Date	Date	Date	Date	
 Ivy								
 Sweet Potato								

Objective: Students will relate the foods that they eat to the original form of the food that you would find in a garden/farm.

- Understand change happens to many things.
- Describe proper body care such as eating a variety of foods.
- Recognize that food is fuel for the body.

Materials

Game:

- Harvest basket
- Plate
- Fresh, whole raspberries
- Raspberry jam
- Apple
- Applesauce
- Corn on the cob (popcorn instead of sweet corn)
- Popped popcorn
- Whole almonds
- Glass of almond milk
- Wheat bundle (free from utah.agclassroom.org)
- Bread



Applesauce:

- 2.5 lbs. apples
- Cutting boards
- Peelers
- Knives
- ½ teaspoon cinnamon
- ¼ teaspoon all spice
- Measuring spoons
- Liquid measuring cup
- Large bowl
- ½ cup lemon juice
- 1 quart water
- Large pot
- Stove/heat
- Large spoon



Bread:

- 2 cups white flour
- 2 cups whole wheat
- 1 pkg. or 2 ¼ teaspoon yeast (quick rise ok!)
- Warm water
- 2 tablespoons sugar
- 2 teaspoons salt
- 1 tablespoon vegetable oil
- Measuring spoons
- Dry measuring cups
- Gallon Ziploc bag



Jam:

- Berries, preferably fresh but frozen will be cheaper
- Large bowl
- Potato masher
- Small jar/serving bowl



Popcorn:

- Popcorn cobs, one for every 1 – 2 students
- Small bowl(s)
- Large pot with cover!
- Vegetable oil
- Stove
- Salt
- Large bowl



Almond milk:

- 2 cups raw almonds
- 6 –12 cups water (depending on the consistency you prefer)
- Blender
- 4 Dates, 4 tablespoons honey, or 4 tablespoons agave (optional)
- Large bowl
- Sieve
- Large spoon
- Medium bowl
- Celery
- Carrots
- Cutting boards
- Knives



Other:

- Plate for each student
- My Plate or My Food Pyramid pictures (attached)

Preparation

- Look for cobs of popcorn in the fall/at the farmer's market. It can also be ordered online at <http://jacksgrainandgourds.homestead.com/redstrawberrypopcorn.html>.
- Soak the raw almonds overnight, or the night before this lesson.
- Recruit parent volunteers to help children at each of the cooking stations.
- For the game, put the whole foods in the basket and the prepared foods on a plate.

Procedure

Engage: Today we are going to start by playing a matching game. Are the items in the basket and the plate the same or different? What do you observe that leads you to conclude that?

- Have students share their observations.
- Let students know that each item on the plate has a match from the basket that shows what the food looked like when it was harvested from a garden/farm.
- Have students take turns finding the matches.

Activity: Now we get a chance to make food from scratch! First everyone needs to wash their hands! Then you will rotate through the centers to make each of the different foods. Work with the adult at each center and remember to BE SAFE! You will have about 10 minutes at each station:

1. Applesauce

- Have a student(s) measure the water and lemon juice.
- Core and peel the apples (probably best for the adult to do this step).
- Review knife safety.
- Have students cut the apples into $\frac{1}{2}$ inch pieces and put into the lemon-water bath.
- Put the apple pieces in a pot with $\frac{1}{2}$ cup lemon-water.
- Measure and add spices.
- Cook on med-high until the apples are soft.
- Smash and serve.

2. Bread (*recipe from utah.agclassroom.org)

- In 1 gallon Ziploc bag, mix $\frac{1}{2}$ cup flour, 1 pkg. or 2 $\frac{1}{4}$ teaspoons yeast, $\frac{1}{2}$ cup warm water, and 2 tablespoons sugar.
- Close bag and knead it with fingers until the ingredients are completely blended. Leave bag closed, with contents in the corner, and let dough rest 10 minutes. (This is a good time to make the jam.)
- Add 2 cups flour, $\frac{3}{4}$ cup warm water, 1 tablespoon vegetable oil, and 2 teaspoons salt to the bag. Mix well.
- Add enough flour to make a stiff dough, about 1 – 1 $\frac{1}{2}$ cups. Close the bag and knead it (you may have to remove some of the air in the bag). Add more flour until the dough no longer sticks to the bag. Let the dough rest 5 minutes.

- Open the bag and allow the dough to fall out onto clean or gloved (food handler’s gloves) hands. Spray the hands or gloves with oil so there will be no sticking. Form the dough into a loaf and place in a loaf pan or onto a cafeteria cookie sheet. Remember the dough will grow 1 ½ times larger, so leave space between loaves if baking on a cookie sheet.
- Allow it to rise 30 (quick rise) to 45 minutes. Bake 30-35 minutes in a 350 degree oven.

Jam

- Have students take turns smashing the berries in the bowl to make a “jam.”

3. Popcorn

- Give each student a cob to remove the kernels.
- Thumbs work best in taking the kernels off the cob.
- Heat oil in a covered pot. (To test the heat, throw a kernel or two in the oil. Once they pop it’s ready.)
- Add the kernels, shaking now and then.
- When you stop hearing pops, remove from heat.
- Be careful when removing cover.

4. Almond Milk

- Add almonds, water, and sweetener (optional) to blender.
- Blend until smooth.
- Pour contents into sieve above large bowl.
- Have students take turns using large spoon to move paste to allow liquid to drip through.
- Pour milk into pitcher, and paste into a bowl.

Celery and carrots

- Have students help cut celery and carrot sticks to later dip in the almond paste/almond butter.

***Question:** We just made a lot of food from raw ingredients. Do you think the food we made is healthy food? Why? Why not? (It is! Addresses four of the main food groups. My Plate and My Food Pyramid images are attached.)*

- **Grains** – great nutrients such as fiber, vitamin B, and minerals
- **Fruits** – fabulous fiber
- **Vegetables** – very important vitamins and nutrients
- **Protein** – provides power for muscles; provides calories/energy

Let’s Review

They say we should eat a rainbow everyday to get all the nutrients our bodies need. Let’s look at what we made/are about to eat today (give students a plate as they make a connection of food to color, food group, or original food from the basket):

- Applesauce – yellow fruit
- Bread with berry jam – yellow grain with red/blue fruit
- Popcorn – white grain
- Almond milk – white protein
- Almond butter with celery and carrots – brown protein with green and orange vegetables

Keep Exploring

- Look in the school garden for more “Garden Treasures” to add to today’s snacks.
- Thresh the wheat by rolling the chaff in between both palms. Then use a grinder to turn the seeds into flour.
- Have students crack their own almonds.
- Share this information from Jones Popcorn:

What makes Popcorn Pop?

The folklore of some Native American tribes told of spirits which dwelled within each kernel of popcorn. The spirits were quiet and content to live on their own, but grew angry if their "houses" were heated. The hotter their homes became, the angrier they got. Shaking the kernels until the heat was too much. Finally they would burst out of their homes and into the air as a disgruntled puff of steam. And that was why they believed that popcorn popped when heated.

Today we know that popcorn pops because each kernel contains a small amount of water, which is stored in the soft starch in the middle of the kernel. This soft starch is surrounded by the kernel's hard outer surface (the hull).

As the kernel heats up, the water begins to expand, and pressure builds against the hard starch. Eventually, this hard surface gives way, causing the popcorn to explode. As it explodes, the soft starch inside the popcorn becomes inflated and bursts, turning the kernel inside out. The steam inside the kernel is released, and the popcorn is popped!

19. From Garden to Tummy – K

Name _____ Date _____

Today you ate 6 different color foods. Draw your healthy snacks here:

red	orange
yellow	green
white	brown

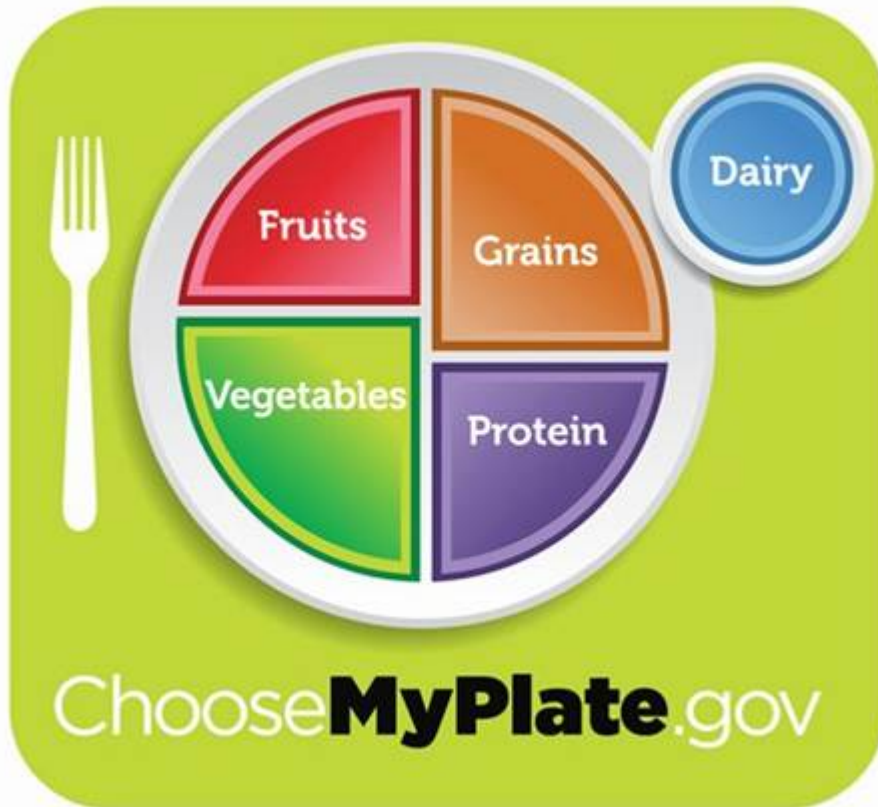

Exercise

- Adults should be physically active for at least 30 minutes most days of the week, children for 60 minutes.
- Sixty to 90 minutes of daily physical activity may be needed to prevent weight gain or sustain weight loss.



New Food Pyramid

Oils

- Most fat should be from fish, nuts and vegetable oils.
- Limit solid fats, such as butter, margarine or lard.
- Keep consumption of saturated fats, trans fats and sodium low.
- Choose foods low in added sugar.

CATEGORY	Grains	Vegetables	Fruits	Milk	Meat and beans
RECOMMENDATION	Half of all grains consumed should be whole grains.	Vary the types of vegetables you eat.	Eat a variety of fruits. Go easy on juices.	Eat low-fat or fat-free dairy products.	Eat lean cuts, seafood and beans. Avoid frying.
DAILY AMOUNT	6 oz.	2.5 cups	2 cups	3 cups	5.5 oz.

Based on a 2,000 calorie diet.

Recommended nutrient intakes at 12-calorie levels can be found on mypyramid.gov.

20. Let's Go Shopping! A Grocery Ad Hunt

Objective: Students use math skills when planning a trip to the grocery store using grocery ads.

- Demonstrate an understanding that print carries “the” message.
- Count to 100 by ones and tens.
- Develop language through viewing media and presenting.

Materials

- Grocery ad(s) for each pair of students
- Scavenger hunt/journal sheet for each student
- Scissors for each pair of students
- Glue stick for each pair of students



Preparation

- Save/collect grocery ads. Many grocery stores and newspapers will save ads for classroom use.
- Copy scavenger hunt/journal page for each student.

Procedure

***Engage:** How many of you have ever gone to the grocery store to buy food? Today we are going to look at grocery ads to see if we can find healthy food for us at a better price!*

- Hand out the ads to the pairs of students.
- Allow them a couple of minutes to look over the ads for things they like to eat.

***Activity:** Grocery Ad Scavenger Hunt*

- Hand out the journal pages.
- Let students know they need to find a picture in the ads that address each one of the scavenger hunt items.
- Once the pair agrees, the picture and price should be cut out and glued to the respective box on the journal page.

Let's Review

- Have each pair of students share one of their scavenger hunt boxes with the class.
- The remaining students will have to determine if the picture matches the given scavenger hunt criteria.

Keep Exploring

- Ask students to find items representing each of the food groups.
- Challenge students to create a healthy meal using the grocery ads.

20. Grocery Ad Hunt – K

Name _____ Date _____

Find, cut, and glue a picture from the grocery ad in each box.

Find a picture of a red fruit.

Find a picture of a green vegetable.

Find a fruit that costs 50¢ or less.

Find a vegetable that costs more than 50¢ .

Coin Identification

Dime



Nickel



Quarter



Penny



©EnchantedLearning.com

21. Now It's Really Cold!

Signs of Life in the Winter Landscape

Objective: Learn about living things in the winter landscape.

- Use observation skills
- Review plant adaptations for winter
- Learn that plants change in different ways throughout the seasons.
- Observe that insects, birds, and other living things often depend on plants for winter survival.

*Note: The making of the mural can be a project for several days.

Materials

- Large piece of paper for winter mural
- Markers, multicolored construction paper, glue, other materials for mural (see class)
- Container for plants material collection (bucket, plastic shoe box, etc.)
- 2 gallon zip lock bags
- 5 aluminum trays (about 6"x12") or large, sturdy paper plates
- Trowel or large metal spoon
- Plastic wrap
- Magnifying glasses
- Plastic spoon for each student
- "Signs of Winter Life" pages (attached)
- Journal pages
- Camera

Preparation

- Print out the "Signs of Winter Life" pages and journal pages.
- Scout out areas around the school where the students can find the most interesting winter plant life examples. Some suggestions are: *Buds, seeds, berries, *tree with no leaves, * tree with few leaves, *tree with lots of leaves, feather, pine cones, twigs, dead leaves, live leaves, grasses, *baby cones on evergreen trees, *bark with holes, *fungi or moss on a tree, animal tracks, *thick bark, pine needles (or leaves from whatever evergreens are in your area), galls, fruit, *insect eggs, *cocoon, *wasp nests, *birds nest, and any other interesting things you find. The ones with asterisks* will be objects that will be photographed rather than collected. Although these objects may be collected if some have fallen on the ground. The students may also carefully remove some seeds, galls, and berries from plants.
- Make a list of things that you find to use in the outside activity with the students.

Procedure

Review:

Wow, it's been pretty cold and we've had some snow too. You have all been wearing your coats, sweaters, and other winter clothes to protect yourselves against the cold. Do you remember when we talked about the ways that plants protect themselves in winter? Remind me again of some of the ways that plants adapt to winter.

- Have a discussion and review the ways that plants adapt to winter. See Lesson #9.

I wonder if the plants really are surviving in the cold. Have you noticed any plants this winter? Are some plants still alive? What is going on in our garden?

- Continue the discussion. Having the students close their eyes and taking some time to imagine the plants outside is a good way to stimulate observations.

Outside!

Let's go outside to observe how the plants around the school grounds and in the garden are doing in this cold weather. Maybe we'll find other surprising things that are alive in winter too. Let's see if plants are also helping out other living creatures.

When we come back in, we'll make a winter mural for our room. Now we'll observe what is really happening outside, collect and photograph some things, and add them to our project.

- Show the students the pictures on the Signs of Winter Life pages. Tell them that they could see some of the things pictured if they look very carefully.
- Take out the freezer bags, collection container, list of things that you found, and trowel.
- Remind them of the outside rules and that they will collect only things that are on the ground or that can be gently removed.
- First have the students spend a few minutes observing the area, in particular looking at trees without leaves. Ask if the trees look different than those they imagined.
- Gently bend some branches to demonstrate that the trees are bare, but still alive! If there is snow on the ground, there will be less around the trees, as they stay warm in winter.
- Get out your list and take the students to different areas to look at what you have found. Have them look for other examples of what you show them. You can divide the class into groups if you have other adults available to lead them.
- They can put samples in the collection container or have you take pictures of all of the "cool" stuff that you don't want to remove such as bark.
- Spend some time checking out the garden area beneath the straw to discover plants that are hibernating for the winter.

You have been looking up and down for winter plant activity, but haven't looked under the leaves on the ground. I wonder if anything is alive there. Let's find out!

- Find a place with a lot of leaf litter. Dig down under the leaves and into the soil to see if you can find some living creatures such as insects or spiders. You may have to dig down under the snow and dig up some areas that are frozen.
- Also look for insect pupae, larvae, and eggs.
- Put a good amount of leaf litter in the freezer bags, seal them, and go back inside.

Question: Did you find signs of life outside? Are the plants surviving? Do the trees look different now than they do in the summer?

- **Collection:**
 - Look through the collection container and discuss some of the interesting things that they found and took pictures of. Figure out how they relate to plants adapting to and surviving winter.
- **Leaf Litter:**
 - Carefully put some of the collected leaf litter in each of the trays or plates. Cover with plastic wrap and set aside to thaw if the materials are still frozen. Put a tray or plate on each group's table.
 - When the leaf litter is thawed, have the students in each group examine the pile using their spoons and magnifying glasses.
 - Next time you go out, return the leaf litter and the creatures to the area where you found them.

Putting it all together: Winter Mural

- Print out the pictures taken outside.
- Hang up the large paper in a spot where the students can work on it.
- Draw a general landscape with several simple evergreen and deciduous trees.
- Have the students help to draw in all of the winter activity that they found outside.
- Attach the photos and real objects (pine cones, seeds, etc.)
- Have the students use their imaginations, knowledge, and ideas from the “Signs of Winter Life” information to add in more of the winter action such as bears hibernating, squirrels eating acorns, worms living deep under the frozen ground, etc.

Let's Review

- *What are some of the coolest things that you found outside in the winter landscape?*
- *Did you find anything surprising?*

Keep Exploring

- Read several books about plant and animal behavior in the winter.

21. Now It's Really Cold!-K

Name _____ Date _____

What did we find under the ground?

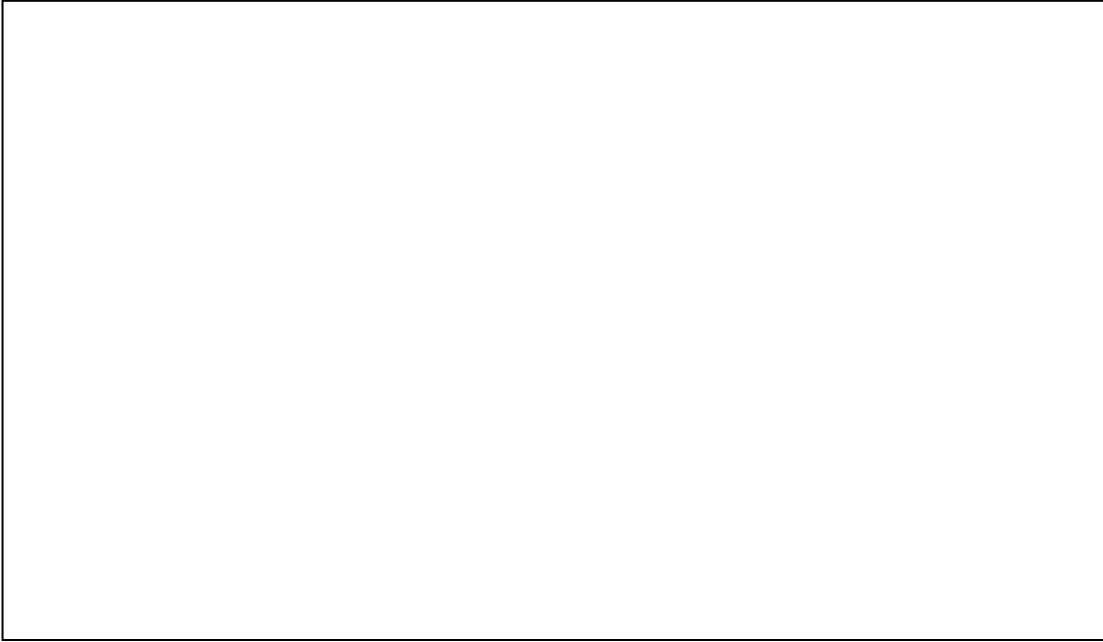

Draw a beautiful winter tree:

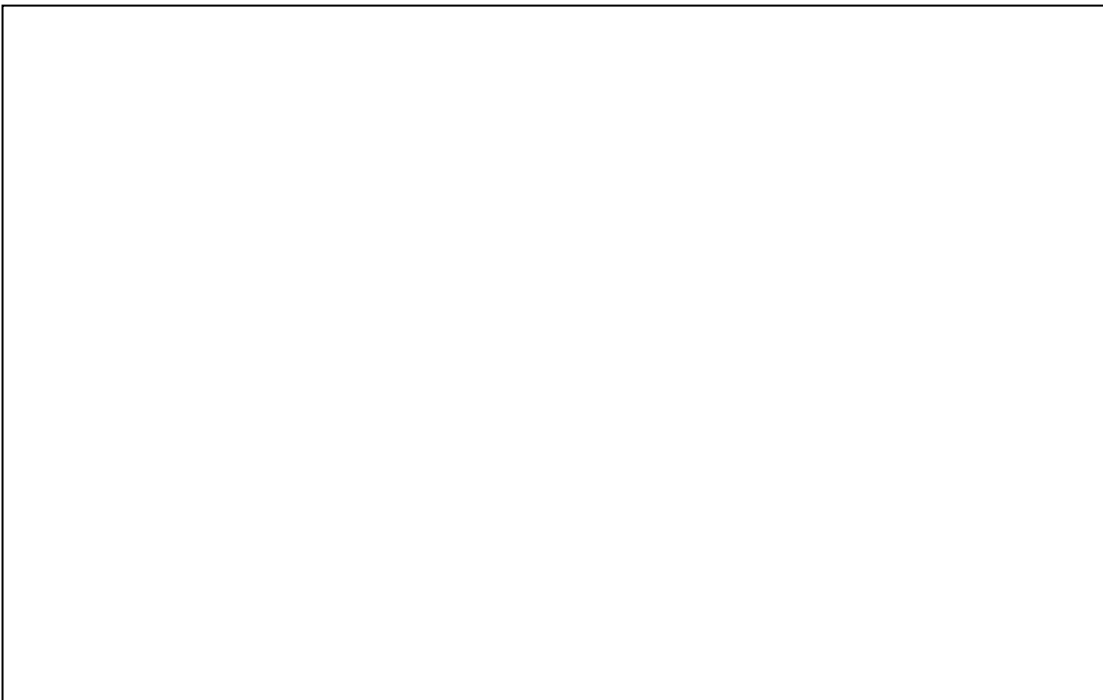

Signs of Winter Life!



Buds



Leaves



Bark



Pupae



Seeds



Gall



Berries



Birds Nest



Insect Eggs



Cones



Feathers



Wasp Nest



Bird



Woodpecker Holes in Bark



Evergreen Tree



Lichen on Bark



Deciduous Tree



Pine Needles and Cones

Objective: Review plant knowledge.

- Answer questions from the Question Book.
- Play a plant knowledge game.
- Practice group cooperation and quick thinking skills

*Note: There are no journal pages this week. This can be a catch up week for journal pages, the Question Book, and writing up experiment results!

Materials

- Question Book
- 25 Index cards
- Marker
- 25 magnets or magnetic strips cut into 25 small pieces (to hold index cards on the board)-Tape could also work.
- Prize(s) for the winning team or teams
- Question and answer key (attached)
- 5 slips of paper-Put the #1 on one of them.

**Preparation**

- Draw the Jeopardy board on the white board.
- Draw a chart on which to keep score.
- Use the key to fill out the questions on the index cards. The point value will be on one side and the question (in the form of an answer as in the TV Jeopardy game) on the other.
- Put the questions up on the board with the point values facing out.
- *Note: This game could also be put together as a Power Point presentation.
- Choose a fun prize or prizes for the winning team or teams. If you want only one team to win, you could use some of the tie breaking questions in an overtime round.

Procedure

Note: If you have been putting questions in the Question Book and answering them, you can skip this part. If you have not been using the Book, take some time at the beginning of this lesson to do so. The students have learned a lot about plants up to this point and hopefully are curious about learning more. Let them know that Botanists never finish learning everything about plants and are always asking new questions! If you do have some great questions in the Question Book for which you have no answers yet, spend some time answering them now or figuring out ways to answer the questions later with research, new experiments, and so on. If you have not already, you could also spend some time before this class to review and talk about the experiment results. Then on to Plant Jeopardy!

Plant Jeopardy

- The students will compete in groups. Use their table groups or put them in new groups that you think will work well. Have them sit close together.
- Explain the rules of the game:
 - The topics are at the top of the board and the point values are showing in each square.
 - Each index card has an answer on it for which the students need to ask a question.
 - Have each group pick one of the pieces of paper. The group that picks the paper with the #1 on it goes first and picks a category and value.
 - You will read the answer. The students in each group must work together to figure out the question. Instruct them to confer quietly so that the next table doesn't hear the question.
 - When the students think that they know the question, they raise their hands.
 - Pick the first group to raise their hands. If they answer correctly, they get the points, if not, go on to the next group and so on.
 - When all of the answers have the correct questions, add up the score and find the winners! Continue on to a tie-breaking round if there is a tie that you want to break.

Let's Review

- *Can you think of some other answers that would be good ones for the game?*
- *What would be some other good topics?*

Keep Exploring

- Come up with another set of answers for the board and play again!

Plant Jeopardy!

Using Plants	Plant Parts	Soil and Soil Organisms	Adaptations and Connections	Plant Needs	Experiments
100	100	100	100	100	100
200	200	200	200	200	200
300	300	300	300	300	300
400	400	400	400	400	400
500	500	500	500	500	500

Plant Jeopardy-K

1. Using Plants

- 100: An orange root that we eat. (*What is a carrot?*)
- 200: Used to make paper and pencils. (*What are trees?*)
- 300: Birds use these for shelter. (*What are trees?*)
- 400: We wear this plant. (*What is cotton?*)
- 500: Plants make this so that we can breath. (*What is oxygen?*)

2. Plant Parts

- 100: Bees love this part of the plant. (*What is a flower?*)
- 200: You eat these plant parts when you eat lettuce. (*What are leaves?*)
- 300: The part of the plant that is underground. (*What is a root?*)
- 400: Pulls up water like a straw. (*What is a stem? What is a root? is also correct.*)
- 500: The plant's food factories. (*What are the leaves?*)

3. Soil and Compost

- 100: A soil creature that can curl up into a ball. (*What is a roly-poly?*)
- 200: One of the larger hard things we found in soil. (*What is a rock?*)
- 300: One of the living things we found in soil. (*Any soil creature will work for this.*)
- 400: Air, water, and minerals. (*What things do plants get from soil?*)
- 500: What you get when "greens and browns" break down. (*What is compost?*)

4. Adaptations and Connections

- 100: What you wear in the winter to stay warm. (*What is a coat? Other answers such as sweaters, more clothes, etc are also correct.*)
- 200: Changes colors in the fall. (*What are leaves?*)
- 300: A squirrel saves these to eat in winter. (*What are acorns?*)
- 400: What we put on our garden plants to help protect them for winter. (*What is straw?*)
- 500: What we found under soil and leaves in the winter. (*What are insects? Other live things such as worms, insect eggs, and roly-polys are also good answers.*)

5. Plant Needs

- 100: Plants drink this through their roots. (*What is water?*)
- 200: Give plants this so that they will have room to grow. (*What is space?*)
- 300: Plant these at the correct depth so plants will grow. (*What are seeds?*)
- 400: *The place plants pull water, minerals, and air from.* (*What is soil?*)
- 500: Plants use this to make food. (*What is light?*)

6. Experiments

- 100: Our Plant Lab gives this to plants. (*What is light?*)
- 200: Plants will wilt if they do not get enough of this. (*What is water?*)

- 300: Plants will turn light green or yellow without this. (*What is light?*)
- 400: A plant part that can grow from a stem in water. (*What is a root?*)
- 500: Too much heat can hurt this part of a seed. (*What is a baby plant or embryo?*)

Plant Jeopardy Tiebreakers and Alternative Questions-K

1. Plant Uses

- We make bed sheets out of this plant. (*What is cotton?*)
- We make pencil erasers from this plant. (*What is a rubber plant?*)

2. Plant Parts

- The hard part covering the seed. (*What is a seed coat?*)
- The part of the plant that gets pollinated by bees. (*What is a flower?*)
- The part of the flower that is colorful. (*What is a petal?*)
- This keeps the plant from falling down. (*What is a root?*)
- Contains seeds (*What is fruit?*)

3. Soil and compost

- Roots grow here to hold up plants. (*What is soil?*)
- Soil has different sizes of these. (*What are particles?*)
- A soil creature that makes tunnels in the soil. (*What is a worm?*)

4. Adaptations and Connections

- Trees lose these in winter so their branches won't break in the snow. (*What are leaves?*)
- Sometimes we hide under ground or under bark in the winter. (*What are insects?*)

5. Plant needs

- We cannot see or feel this thing that plants need, but it is all around us. (*What is air?*)
- These are like vitamins for plants. (*What are minerals?*)

6. Experiments

- Take the bag off of the leaves to make the plant turn this color. (*What is green?*)
- These plant parts can grow out a sweet potato when it is in water. (*What are roots, stems, and leaves?*)

23. Flower Power!

The Many Benefits of Planting Flowers

Objective: Students plant flower seeds to later place in the school garden, attract butterflies and hummingbirds, and complete a community service learning project.

- Identify most objects are made of parts.
- Explain plant needs.
- Recognize the physical and human characteristics of their surroundings.

Materials

- Flower for each student (ideally different flower for each person)
- Vase
- Large cloth
- Flower seed packets
- 2-inch pots (2 per student)
- Soil (enough to fill each of the pots)
- Trowels (5)
- Watering can
- Wooden craft sticks (1 per pot)
- Sharpies, pens, pencils (1 per student)
- Grow lights



Preparation

- Cut or buy a flower for each student. Keep them in a vase with water. (If purchased, trim the ends before placing in the vase. They will stay fresher!)
- Hide the bouquet under a large cloth so the students cannot see what is underneath.
- Buy seed packets for annual flowers that will bloom quickly. Salt Lake City valley floor is zone 6. Get a variety of colors, shapes, and sizes. There are several annual suggestions on the attached handout, “Plants That Attract Beneficial Insects.”
- Identify potential recipients in the community (Nearby senior center? Recipients of Meals on Wheels? Nearby hospital? Pediatrics floor?) for the students’ service learning project.

Procedure

Question: *How are you feeling today?*

- Take students answers.
- Let them know you have something that you are going to give each of them.
- Reveal the flowers.

Question: *How are you feeling now? What do you think of these flowers?*

- Take all answers facilitating as many descriptive words as possible.
- This sets up the Flower Power service learning project as a gesture that helps people in the community feel good/brightens up their day.

Activity: *Let's play a game called, "Clump."*

- Students are to "mingle"/casually walk around a given space.
- When you call out a characteristic of the flowers (i.e. same color, same number of petals, same shape, can/can't see the stamen and pistil, etc.), students must clump together with other students holding flowers with the same characteristics.
- Have student clumps take turns describing/identifying which characteristic their clump shares (i.e. red flowers, 5 petals, trumpet shaped, etc.).
- If a student(s) is left out, he/she can clump by you until it is time to mingle again.
- It is nice to end the game with, "Clump if you have a flower!" so that the class is together/no one is left out.

Question: *We all have beautiful flowers in our hands, but they won't stay this way. What is going to happen to them? Why? (They will wilt because they have been cut from the plant and no longer have their basic needs met.)*

Question: *What is a way that we could give someone a flower but have it live longer? (Give them the whole plant!) What are the basic needs of a plant?*

Activity: *Today we are going to plant seeds so we can grow our own flowers! We will put some of the flowers in the garden to add vibrant colors and also to attract butterflies, hummingbirds, and beneficial insects. We will also share some of the flowers with members of our community!*

- Students should choose the type of flower(s) they would like to plant. Each student should plant two pots: one for the school garden and one to give to someone else.
- Each student should write the name of the flower and the date on one side of the craft stick, and his/her own name on the other.
- To plant, students should pick a pot, fill it with moistened soil (damp like a wrung out sponge), plant 2-3 seeds, and cover with soil. (Refer to the Planting Seeds document with lesson 15.)
- Place newly seeded pots under grow lights.
- *Once plants have reached 1"-2", thin to one plant per pot.
- **If a pot remains empty after the recommended germination period (you'll find this information on the seed packet), reseed with 3-4 seeds per pot.

Question: *We mentioned giving some of our flowers to members in the community. Who should we give them to?*

- Facilitate discussion of who is in their community.
- Who might benefit from the flowers? Nearby senior center? Recipients of Meals on Wheels? Nearby hospital? Pediatrics floor?
- Hold class vote.

Let's Review

- *What did we plant today? Why?*
- *Who will benefit from our Flower Power? (the class, the school, other community members, butterflies, hummingbirds, beneficial insects)*

Keep Exploring

- In the garden, add a shallow rock or a bowl with a sponge and water as a drinking place for the butterflies. Change the water regularly.

23. Flower Power-K

Name _____ Date _____

You planted seeds today. Draw the flower that will bloom from the plant you are growing.

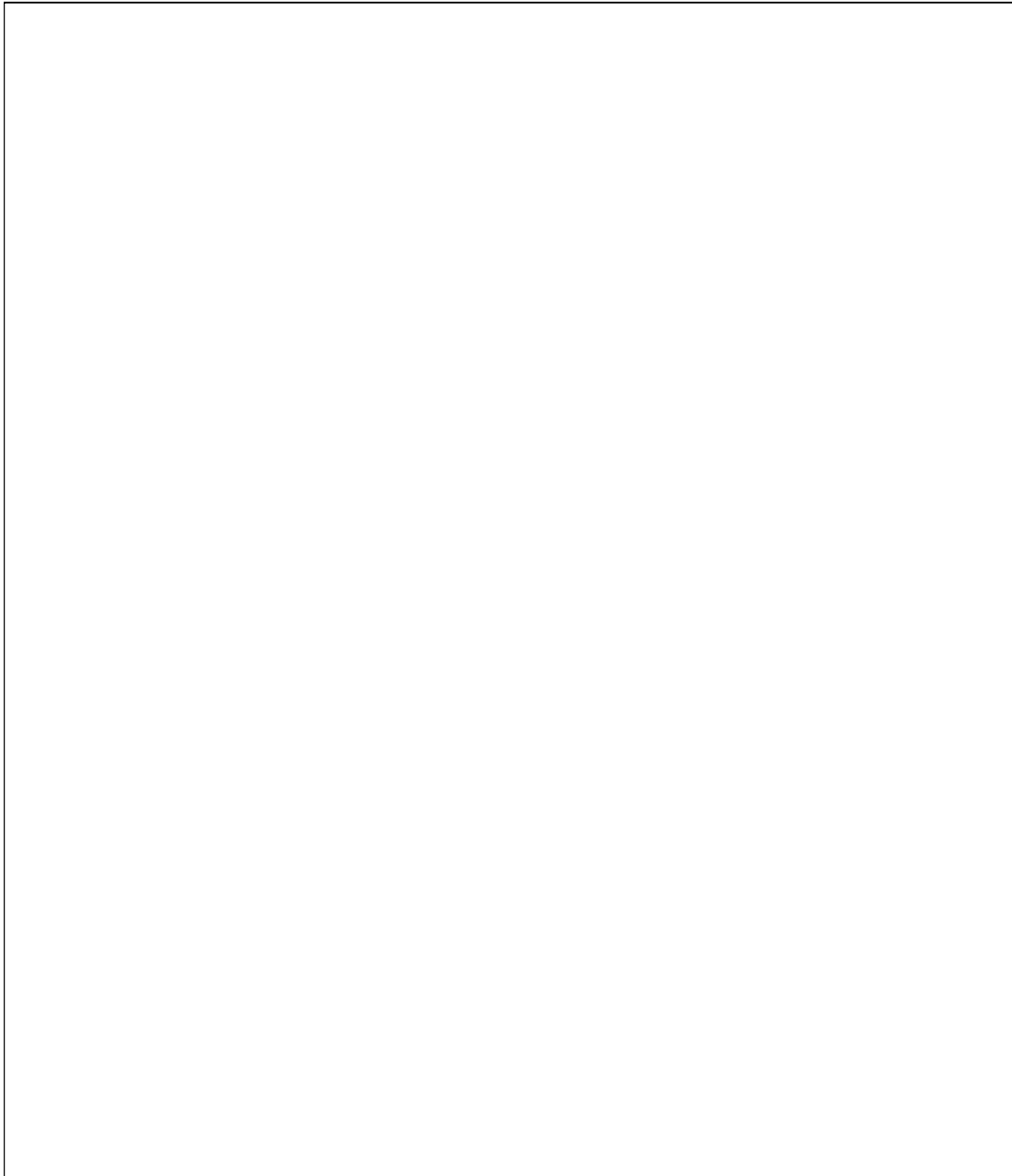

The name of my flower is _____.

Plants That Attract Beneficial Insects

Botanical Name	Common Name	Bloom Time	Zone	Code
<i>Achillea filipendulina</i>	Fern-leaf yarrow	Summer through fall	5	lw, lb, hf, w
<i>Achillea millefolium</i>	Common yarrow	Summer through early fall	2	lb, hf, w
<i>Ajuga reptans</i>	Carpet bugleweed	Late spring or early summer	4	lb, hf
<i>Allium tanguticum</i>	Lavender globe lily	Summer	4	hf, w
<i>Alyssum saxatile</i>	Basket of Gold	Early spring	3	lb, hf
<i>Anethum graveolens</i>	Dill	Summer	annual	lw, lb, hf, w
<i>Angelica gigas</i>	Angelica	Mid to late summer	5	lw
<i>Anthemis tinctoria</i>	Golden marguerite	Spring through fall	6	lw, lb, hf, w, t
<i>Asclepias tuberosa</i>	Butterfly weed	Summer	4	lb
<i>Aster alpinus</i>	Dwarf alpine aster	Summer	3	hf
<i>Astrantia major</i>	Masterwort	Summer	5	hf, w
<i>Atriplex canescens</i>	Four-wing saltbush	Summer	7	lw, lb, hf
<i>Callirhoe involucrata</i>	Purple poppy mallow	Summer	4	lw, hf, w
<i>Carum Carvi</i>	Caraway	Summer	bi-an	lw, hf, w, s
<i>Chrysanthemum parthenium</i>	Feverfew	Summer through early fall	6	hf
<i>Coriandrum sativum</i>	Coriander	Summer through fall	annual	lw, lb, hf, w
<i>Cosmos bipinnatus</i>	Cosmos - white sensation	Summer through fall	annual	lw, hf, w, s
<i>Daucus Carota</i>	Queen annes lace	Summer through fall	annual	lw, lb, hf, w
<i>Fagopyrum esculentum</i>	Buckwheat	Early fall	annual	lb, hf, t
<i>Foeniculum vulgare</i>	Fennel	Summer	5	lw, lb, hf, w, s
<i>Helianthus maximiliani</i>	Prairie sunflower	Late summer	4	lw, lb
<i>Lavandula angustifolia</i>	English lavender	Summer	5	hf
<i>Limnanthes douglasii</i>	Poached egg plant	Summer	annual	hf
<i>Limonium latifolium</i>	Statice	Summer through fall	5	hf, w
<i>Linaria vulgaris</i>	Butter and eggs	Summer and early fall	4	hf, w
<i>Lobelia erinus</i>	Edging lobelia	Summer	annual	hf, w
<i>Lobularia maritima</i>	Sweet alyssum - white	Summer	annual	hf, w

Botanical Name	Common Name	Bloom Time	Zone	Code
<i>Medicago sativa</i>	Alfalfa	Summer through fall	3	bb, db, mpb
<i>Melissa officinalis</i>	Lemon balm	Summer	4	hf, w, t
<i>Mentha pulegium</i>	Pennyroyal	Summer	7	hf, w, t
<i>Mentha spicata</i>	Spearmint	Summer	4	hf, s
<i>Monarda fistulosa</i>	Wild bergamot	Summer	4	hf
<i>Penstemon strictus</i>	Rocky mountain penstemon	Late spring through summer	3	lb, hf
<i>Petroselinum crispum</i>	Parsley	Summer	bi-an	hf, w, t
<i>Phacelia tanacetifolia</i>	Phacelia	Late spring to early summer	annual	t
<i>Potentilla recta 'warrenii'</i>	Sulfur cinquefoil	summer and early fall	4	lb, hf, w
<i>Potentilla villosa</i>	Alpine cinquefoil	Spring	5	lb, hf, w
<i>Rudbeckia fulgida</i>	Gloriosa daisy	Late summer through fall	3	hf
<i>Sedum kamtschaticum</i>	Orange stonecrop	Summer	4	hf, w
<i>Sedum spurium & album</i>	Stonecrops	Summer	5	hf
<i>Solidago virgaurea</i>	Peter Pan goldenrod	Late summer thru early fall	5	hf, mpb
<i>Stachys officinalis</i>	Wood betony	Spring/summer	5	hf
<i>Tagetes tenuifolia</i>	Marigold - lemon gem	Summer through fall	annual	lb, hf, w, s
<i>Tanacetum vulgare</i>	Tansy	Late summer through fall	4	lw, lb, w, t
<i>Taraxacum officinale</i>	Dandelion	Spring and fall	3	lw, lb
<i>Thymus serpyllum coccineus</i>	Crimson thyme	Summer	5	hf, w, t
<i>Veronica spicata</i>	Spike speedwell	Summer	3	lb, hf
<i>Vicia villosa</i>	Hairy vetch	Summer through fall	3	lb
<i>Zinnia elegans</i>	Zinnia - liliput	Summer through frost	annual	hf, w
Code:				
lw=lacewings	w=parasitic mini wasps	mpb=minute pirate bugs		
lb=ladybugs	t=tachnid flies	db=damsel bugs		
hf=hover flies	s=spiders	bb=big eyed bugs		

www.tomclothier.hort.net

Objective: Students will make a salad that represents each of the colors of the rainbow.

- Identify the purposes of text.
- Demonstrate basic safety with food preparation and knife safety.
- Describe taking proper care of the body by eating a variety of foods.
- Recognize that food is fuel for the body.

Materials

- *Eat Like a Rainbow* CD by Jay Mankita
- Lyrics to “Eat Like a Rainbow” (attached)
- Lettuce from the class grow lights seeded in Lesson 15
- Radishes from Lesson 17
- Fruits/vegetables that are red, orange, yellow, green, blue, purple, and white (a list of examples is attached)
- Colanders
- Cutting boards
- Knives
- Large bowl (for the class salad)
- Bowls (one for each student)
- Forks (one for each student)
- Salad dressing



Preparation

- Borrow the *Eat Like a Rainbow* CD by Jay Mankita from the Salt Lake City Public Library (there are multiple copies within circulation).
- Check how much food can be harvested from the classroom and school garden. Buy fruits/vegetables to supplement any missing colors.
- Print and hang the color-nutrient picture cards where each of the food teams will be doing their food prep.

Procedure

Engage!

- Play the song “Eat Like a Rainbow” by Jay Mankita. (optional: Let the students dance!)
- Play the song a second time. Have the children sit and listen to the words to find what the song is talking about.
- If needed, lyrics are attached in order for students to read the words while they are being sung.

Question: What is this song telling us? (Eating foods in a rainbow of colors will help your body be healthy.)

Activity: Today we are going to eat a rainbow of colors, starting with the lettuce we have grown in our very own classroom!

- Split the class into six teams. Everyone should wash hands!
- The lettuce team (green) will need to **carefully** pull (two hand picking rule!) the **outer** leaves of the lettuce. This will allow the inner leaves to continue to grow for a later harvest. Students should wash the lettuce and tear into bite-size pieces.
- The radish team (red) should carefully pull the roots from the soil, wash, and chop.
- Harvest produce from the school garden, if possible, with the students as well.
- Have the other teams prepare the other color foods you have provided.
- Keep teams with their respective color foods and signs. No one should eat yet!

Question: Why is it important to eat a rainbow of foods every day? How does it help our body?

- Have each team look at their picture cards to find the specific way the body is helped by the foods of that color.
- Teams should take turns sharing why their color food is important/helpful to the body, and then pour that color ingredient into a giant salad bowl.
- Help students elaborate on the benefits each nutrient provides. (ex. What does it mean to have a healthy immune system? What does it mean to have healthy aging?)

Activity: Eat the class rainbow salad!

Let's Review

Activity: Listen to/read the song again.

- Have students group together in their color teams. When their color is sung in the song, the team needs to jump up, hold up their sign, and sing their color name.
- Listen/read again. This time when their color comes up, the team needs to jump up, hold up their sign, and sing their color function (ex. helps the heart, teeth, and bones).
- If interest is still there, have students switch cards to learn each other's colors and functions.

Keep Exploring

- Write another verse(s) to Eat Like a Rainbow.

24. Eat a Rainbow-K

Name _____ Date _____

Draw the part of the salad you ate today for each of the colors.

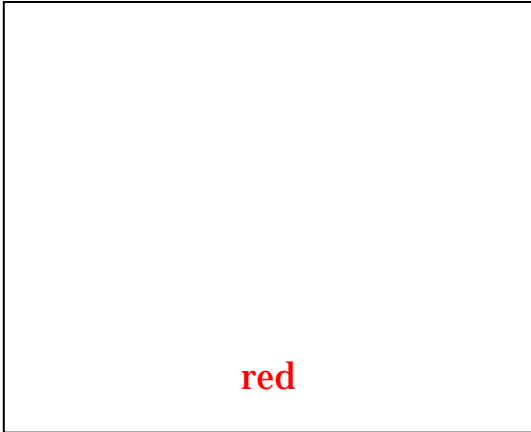

red

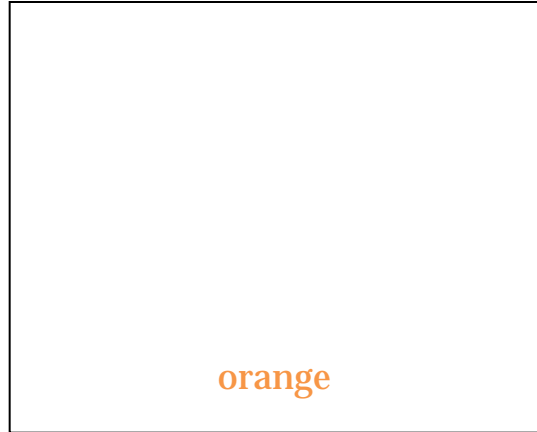

orange

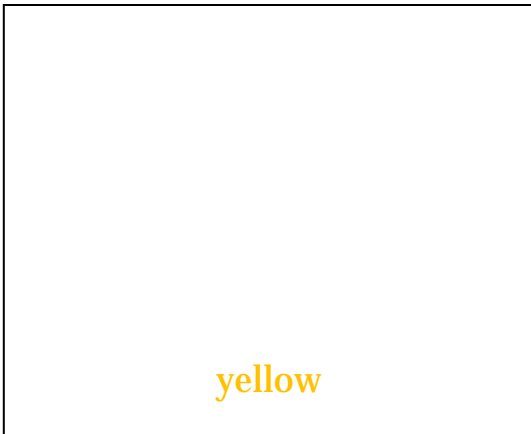

yellow

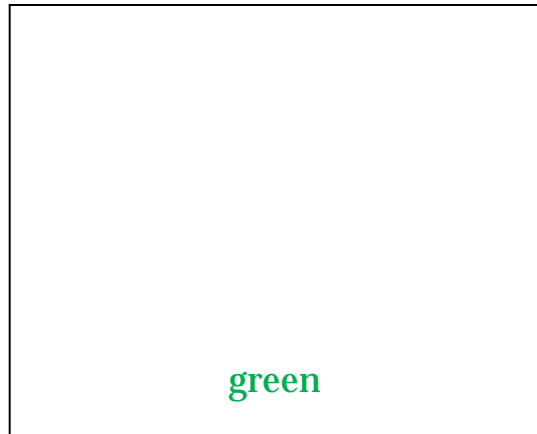

green

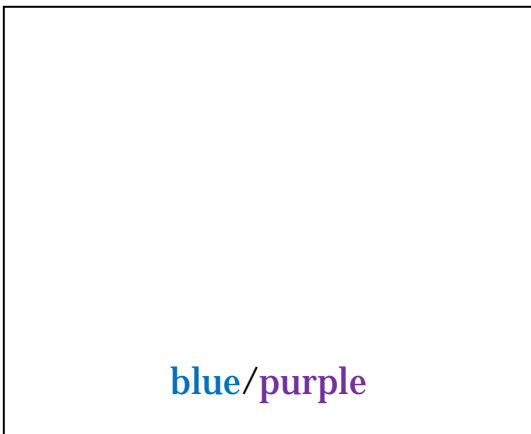

blue/purple

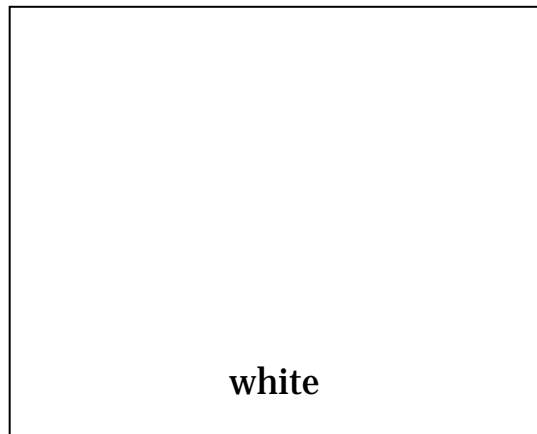

white

Eat Like A Rainbow

Written by: Jay Mankita

I like to eat like a rainbow
Builds my body and it makes my brain grow
Helps my heart beat and my blood flow
I like to eat like a rainbow

Red, orange, yellow, green
The tastiest colors I've ever seen
I like to eat food that's purple and blue
Colorful foods are healthier too

Colorful food makes a colorful meal
And that really colors the way that I feel
I'm livin' in a colorful way
I eat like a rainbow every day

Colorful sunsets, and colorful jokes
Colorful flowers and colorful folks
Colorful shirts and colorful pants
I eat from the rainbow of colorful plants

Red

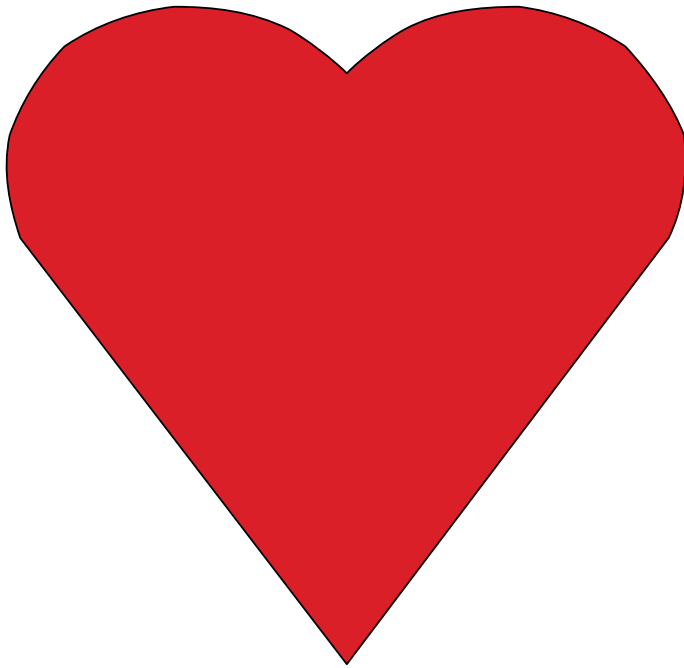

heart



memory

Orange



heart



vision

Yellow

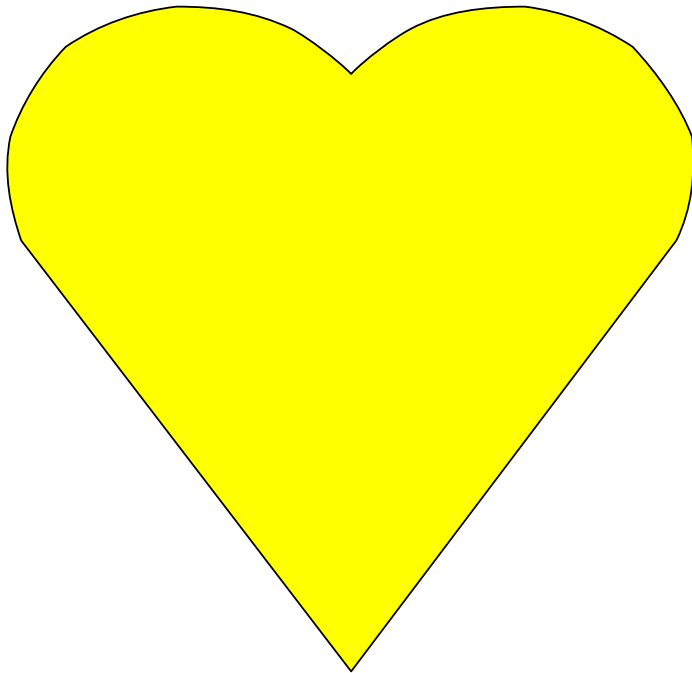

heart



immune system

Green

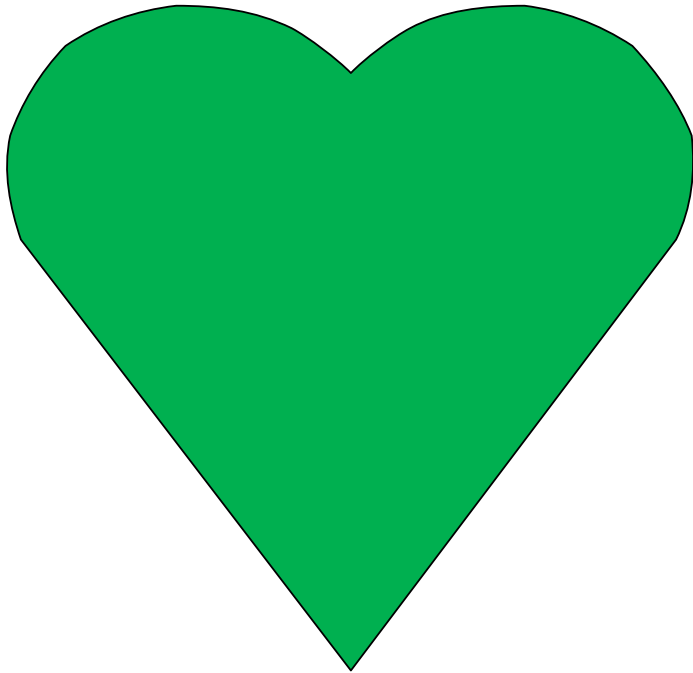

heart



teeth and bones

Blue and Purple

and

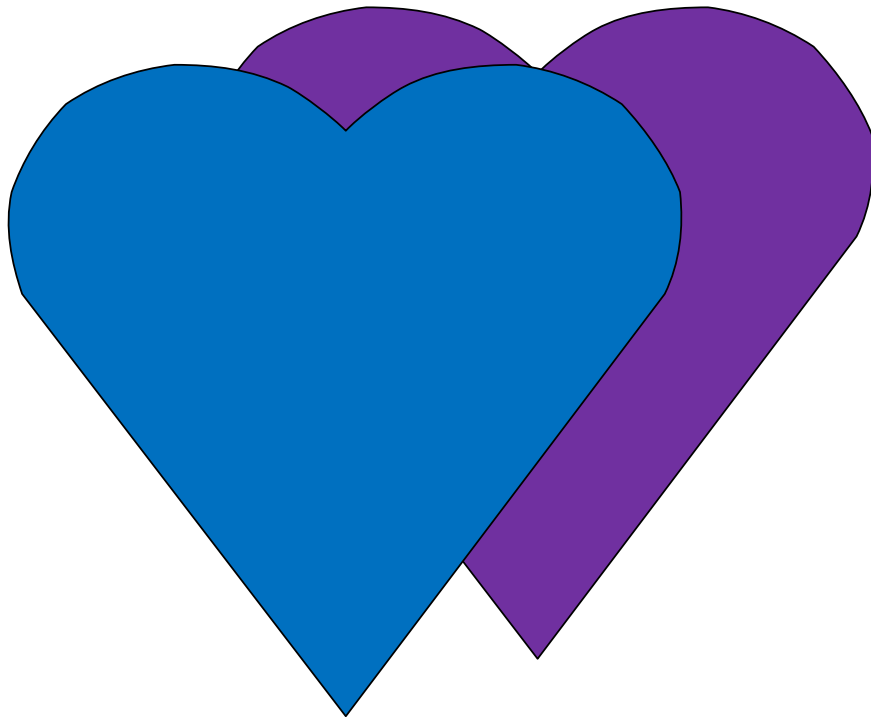

heart



healthy aging

White

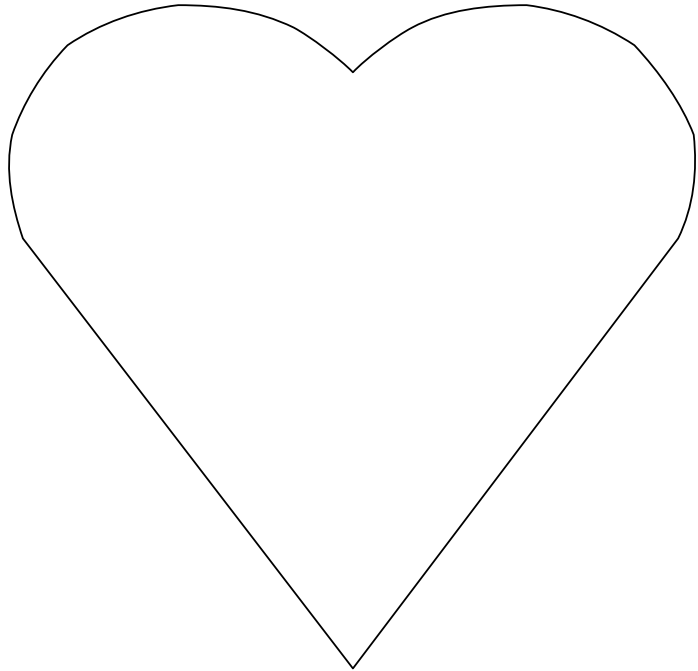

heart



muscle function

The Nutrients in Colors

Red:

Contain the phytochemicals lycopene and anthocyanin, which improve heart and urinary tract health, improve memory, and decrease the risk of cancer.

Orange/Yellow:

Contain vitamin C and carotenoids (a precursor to vitamin A) and bioflavonoids, which help with heart health, vision, immune system health, and decrease the risk of cancer. Good source of folate (important for pregnant women for proper fetus neural development).

White:

Contain the phytochemical allicin (from the onion or Allium family) and potassium, which improve heart health and nerve/muscle function, decrease cancer risk, and can help maintain healthy cholesterol levels (think garlic).

Green:

Contain lutein and indoles which help maintain strong teeth and bones, maintain heart health, and decrease risk of cancer. Good source of vitamin K, which helps with blood clotting, and calcium (bone health) and iron (blood health).

Blue/Purple:

Contain the phytochemicals anthocyanin and a variety of phenolics, which maintain heart health, memory, help with healthy aging, and--you guessed it--decrease the risk of cancer (specifically the prevention of tumor growth).

You probably noticed, there is a lot of overlap of function, but the means (ie phytochemicals) are different. All of these colors have a considerable amount of vitamin C (strong antioxidant), A (vision), and potassium (muscle and nerve function).

Red	Orange/Yellow	White/Brown	Green	Blue/Purple
Apples	Apricots	Bananas	Asparagus	Blackberries
Beets	Butternut Squash	Beans	Avocados	Black Currents
Cherries	Cantaloupe	Brown Pears	Broccoli	Blueberries
Cranberries	Carrots	Cauliflower	Brussels	Dried Plums
Radishes	Corn	Dates	Sprouts	(Prunes)
Raspberries	Mangoes	Garlic	Celery	Eggplant
Red Beans	Nectarines	Ginger	Cucumbers	Purple Figs
Red Cabbage	Oranges	Jicama	Green Beans	Plums
Red Grapes	Papayas	Lentils	Green Cabbage	Purple Grapes
Red Pears	Peaches	Mushrooms	Green Grapes	Purple Peppers
Red Peppers	Yellow Pears	Onions	Green Pears	Purple Potatoes
Red Potatoes	Pineapple	Parsnips	Green Pepper	
Rhubarb	Sweet	White Potatoes	Kiwifruit	
Strawberries	Potatoes/Yams	Raisins	Lettuce	
Tomatoes	Tangerines	Turnips	Peas	
Watermelon	Yellow Peppers	White Nectarines	Spinach	
	Grapefruit		Zucchini	

25. Planting a Cool Rainbow Growing Cool Weather Crops

Objective: students conduct a soil compaction experiment while planting potatoes, and plant a rainbow of cool weather crops.

- Demonstrate all living organisms have similar needs.
- Modify how change happens to many things.
- Create and describe patterns.

Materials

- Shovel(s)
- Potato seed (see tips below)
- Compost
- Straw/mulch (enough so that the mulch is 4-6 inches deep over the garden)
- Color-nutrient picture cards from lesson 24
- Cool weather crop seeds (see list of recommendations below)
- Watering cans
- Wooden craft sticks (one for each crop to be planted)
- Sharpies



Preparation

- Buy potato seed from a local nursery or garden shop such as Western Garden Center (550 South 600 East, 801-364-7871) or Millcreek Gardens (3500 South 900 East, 801-487-4131). Do not buy potatoes from the grocery store as they have often been sprayed with a growth inhibitor. Nursery potatoes have also often been tested to be disease-free which will help protect your garden. Examples of early varieties are Charlotte, White Rose, Norgold Russet, Yellow Finnish, Irish Cobbler, and Red Norland. Each plant will produce 1 – 2 handfuls of new potatoes.
- If you have larger potato seed with multiple eyes, you can cut the potato seed to make more plants. Each section should have 2 -3 eyes. The larger the potato piece, the more successful the sprouts will be. Potato seed should be cut **a day or two in advance** so that the potato can scab over, dry out. This will prevent the potato from molding in the ground.
- Purchase cool weather crop seeds. Red: radishes (fast) and beets (sweet). Orange: carrots (kids love pulling them from the ground). Yellow: Golden Beets (surprise!). Green: sorrel (lemony!), Rainbow Chard (rainbow colored petioles and veins), and spinach. Purple: Purple Dragon and Purple Haze Carrots (purple on the outside, orange inside). White: parsnips and turnips (the potatoes are in this category too).
- Identify a large space in which potatoes can be planted. The experiment calls for two different scenarios. However, the space in which these two scenarios take place would ideally be next to each other (same soil, same sunlight, same exposure to weather, etc.).

Procedure

Engage! Let's play a game about one of the basic needs of plants, the one that is often forgotten.

- First students should spread out so that they cannot reach another student, even if their arms and legs are as wide as they can be.
- Then students should move closer together so that their fingertips are touching while their arms and legs are stretched out wide.
- Next students should put their hands to their hips and move closer so their elbows are touching.
- Ask how the students are feeling/if they are comfortable.
- Then have the students put their arms at their sides so they can stand shoulder to shoulder with each other. They should all be linked.
- Last, have everyone stand so their feet are touching too.

Question: Let's have our garden lesson like this today. Class, what are the basic needs of plants? (water, light, food, air, and SPACE!)

- Tell students they will be planting potatoes and other seeds that like the cool weather.
- With their feet still touching and being **very careful**, they should squat down to pretend they are little potatoes being planted in the ground.
- Next you have to cover them with soil. Spread your arms over the students and pretend to pat down the soil so they get pushed down even more!

Question: How are you feeling, Potatoes? Do you feel healthy and comfortable? Do you think you could each grow into a nice strong plant? (No!)

- Have students reverse the steps of the engage activity so they are once again spread out.
- Once they have their own space, have them squat down again to be a little potato.
- Now go around and lightly sprinkle them with soil.

Question: Are you happier, healthier potatoes now that you have your own space? (YES!)

Activity: Let's conduct an experiment while planting potatoes. In one half of our planting area we will give the potatoes plenty of space as well as light, fluffy soil. In the other half we will plant the potatoes close together AND we will step and stomp the soil on top of them.

- On the light, fluffy side, have students dig a trench that is 6 inches deep. Put extra soil to the side of the trench as it will be needed as the potatoes are growing. Potatoes should be placed, eyes up, about a foot apart from each other. If needed, additional trenches should be dug two feet away from each other. Lightly sprinkle compost and soil to cover potatoes by 1 inch.
- On the smashed side, dig a hole 6 inches deep. Place all the potatoes in the hole so they are eyes up but also touching one another. Add the same amount of compost as the first side as well as soil so that the potatoes are covered by 1 inch.
- Next have students walk, run, jump, and stomp on the potatoes in the hole on the smashed side. Not only are the potatoes close to each other, but now they are experiencing soil compaction. (The light, fluffy side should remain untouched.)

- Label both sides.
- Cover with straw/mulch. (This will help with water retention.)
- Water well.

Question: *Now we are going to plant more vegetables that like to grow in cooler weather. We are going to grow a rainbow of colors. Why is it important to grow a rainbow instead of just one color? (Each color has nutrients that help different parts of our body. We need all of them to be healthy!)*

- As students name the colors/benefits, hand them a color-nutrient picture card from lesson 24 to old up as a visual aid to the rest of the class.

Activity: *Let's plant our rainbow!*

- Plant the vegetable seeds according to the directions on the back of the seed packets.
- Create fun patterns with the different crops.
- Label all crops with the craft sticks and sharpies.
- Mulch
- Water

Let's Review

- *What are plants basic needs?*
- *What is our experiment testing?*
- *Why did we plant a rainbow?*

Keep Exploring

- **Hilling up** – As potatoes plants grow, the tubers will grow near the surface of the soil. To prevent potatoes from turning green, a sign of high concentrations of the toxin solanine, potatoes must hilled up. This simply means going out every week or so and adding more soil to cover the emerging tubers. Be sure to do this little by little as the plant likes the sunlight.
- *Solanine is a toxin that needs to be eaten in high concentrations to result in sickness. For potatoes, an adult would have to eat 4 ½ pounds in a single sitting to be sick. For children it would be less, but still not worth a belly ache. However, the concentration of solanine in the leaves and stems of the potato plant are very high. No one should eat the leaves and stems!

25. Plant a Cool Rainbow-K

Name _____ Date _____

Draw the two different ways you planted potatoes today:

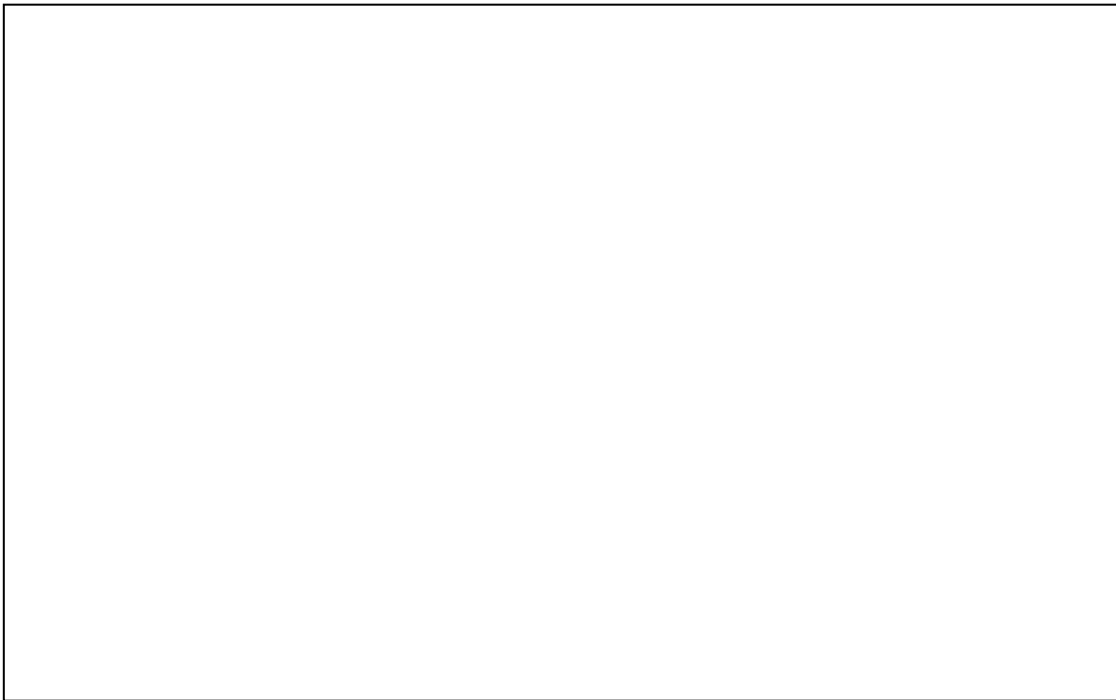
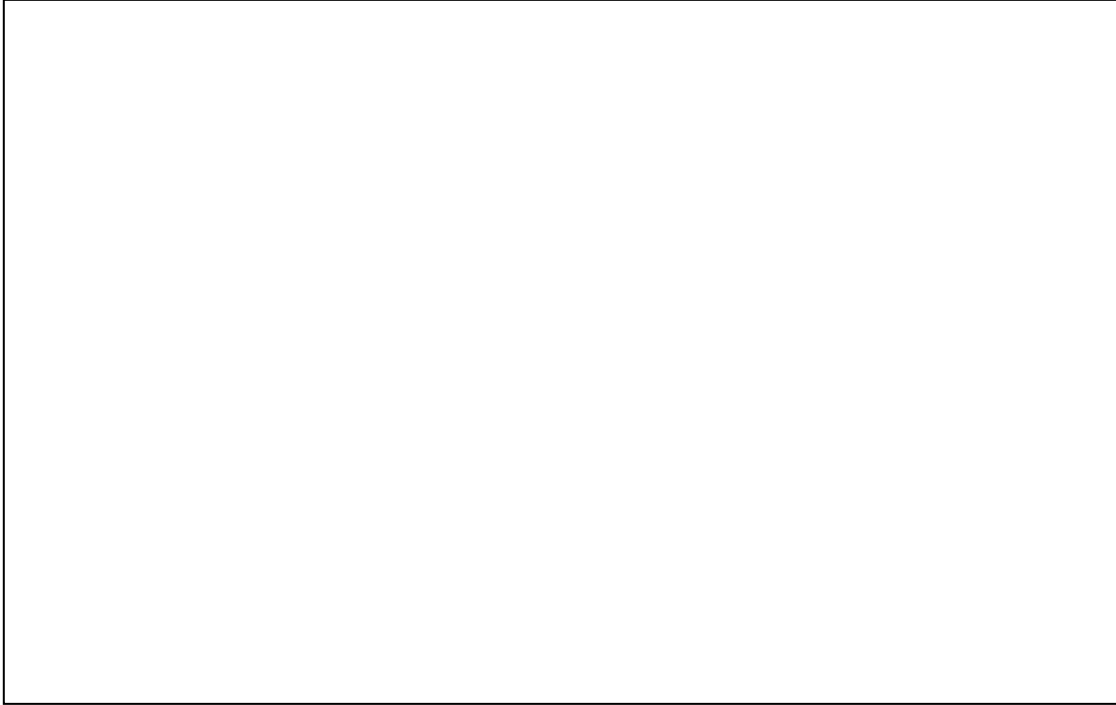

Objective: Write poetry based on observations in the garden

- Sharpen observation skills
- Learn and practice creative writing skills

Materials

- 2-4 index cards for each student (Strips of paper would work too.)
- Marker
- 1 penny for each student
- Several familiar objects from the classroom such as a book, crayon, pencil holder, etc. See the first observation exercise for how the object will be used.
- Scotch tape
- 10-20 blank pieces of paper



Preparation

- Choose some areas in the garden that will be good for observations.
- Read some poetry to the class. There are many age appropriate garden inspired books of poetry available. [Insectlopedia](#), by Douglas Florian and [Oddhopper Opera: A Bug's Garden of Verses](#), by Kurt Cyrus are some fun books with poems inspired by insects.

Procedure

Have the students sit in a circle.

***Observation:** I have some objects here that you see in or out of the classroom everyday. We never think to describe these things, as we already know what they are. But what if we didn't know what they were and we needed to describe them to someone? We want this person to be able to tell us what the object is just from our description.*

- Have one student volunteer to leave the classroom for a minute.
- Pass out pennies to the rest of the students. Have the students use their eyes, noses, hands, and ears to observe the penny, then put it in a pocket or hide it in their hands.
- Have the volunteer return to the classroom.
- Then have the students take turns describing the penny in as much detail (shape, color, odor, weight, etc.) as possible without telling the volunteer what the object is.
- Encourage their use of a variety of descriptive words until the volunteer guesses what the object is.
- Have another volunteer leave the classroom. Hold up a larger classroom object in front of the class. When the volunteer returns, have the students describe it in detail.
- Repeat with one more object and one more volunteer so that they are really focused on the observation and descriptive process.

Let's go outside and spend some time closely observing and then describing our garden. Do you think that you will notice things that you have not noticed before? We'll create some poems as well.

- Bring out the index cards, marker, tape, and blank pieces of paper.

Jigsaw Poem I

- Have the students spend some time observing the garden and thinking of ways to describe it.
- Remind them to use all of their senses and look at the garden as if they will be describing it to someone else who has never seen it before.
- After five minutes or so, ask the students to come into a circle.
- Tell them to pick a word or several words to describe the garden.
- Go to each of them in turn and have them whisper the word or words to you. Write their thoughts down on an index card. (Hopefully they will come up with different words if they don't hear what their neighbor has to say!)
- Collect all of the cards and shuffle them.
- Divide the students into five groups.
- Pass out a card to each student in random order. Say the words as you hand them out.
- Have each group read through the cards and decide in which order they would like to put them to create a descriptive poem.
- Let each group present their creation by standing in order with the words held in front of them. One person in the group will read their poem.
- After reading they will tape the words in order on a piece of the blank paper.
- After all of the groups have presented, they will create another poem.

Jigsaw Poem II

- Continue with the same groups and this time have the students go to a part of the garden where they will choose something, such as a particular plant or part of a plant, to describe. This is an exercise in going from a large scale (the whole garden as in Poem I) to small scale observation.
- Remind the students to focus just on that object, closely observe, and then, as in Poem I, decide on a word or words for you to put on the index card.
- Collect, shuffle, redistribute, and read the new poems as in Poem I. Tape these poems onto papers also. You can create as many poems as you like using this method.
- Return to the classroom and hang up the poems.

Let's Review

- *What did you notice in the garden that you may not have noticed before?*
- *What are some words that are in the poems that you would not thought of before to describe the garden? Look at the displayed poems.*

Keep Exploring

- Illustrate the Jigsaw Poems.

Curricula funding provided by The Humana Foundation for the Salt Lake City School District

26. Poetry in the Garden-K

Name _____ Date _____

Copy your favorite garden poem here:

Draw a picture to go with the poem:



Objective: Students will explore the garden looking for signs of spring in which the data will be used to create a graph.

- Change happens to many things.
- Some changes are so slow or so fast that they are hard to see.
- Classify objects into given categories; count the numbers of objects in each category and sort the categories by count.

Materials

- Digital camera
- Journal pages
- Clipboards
- Pencils
- Large, lined chart paper
- Markers
- Mini post-it notes, various colors (optional)



Preparation

- Print journal pages for each student.

Procedure

***Engage!** Let's take a look at our garden together. Now that it is April, I want you to look, from where we are standing right now, for signs of spring. Do you remember looking at the winter landscape (lesson 21)? What are some differences? If you spot one, let us know by raising your hand. You will lead the class to your sign of spring so we can all look at it and **you** can take a picture of it! You should all keep a look out for more signs of spring as students are leading us to different areas of the garden. Remember where your sign of spring is because we are all going to stick together and take turns.*

- Double check the image taken captured the sign of spring.
- You may also want to take a second picture with the student pointing to his/her sign.
- Possibilities include but are not limited to:
 - Snow melting
 - Garlic sprouting
 - Flower buds opening
 - Trees leafing out
 - Grass greening
 - Presence of active insects
 - Decomposed fall leaves
 - Rainbow garden of cool weather crops has sprouted
 - Eggs or baby birds in nests

- *Activity: Now you will go through the garden on your own looking for more examples of signs of spring. For example, if George found flower buds in the trees, can you find flower buds somewhere else? If Sally found decomposing leaves by the fence, can you find some somewhere else? Fill out your journal sheets with the signs of spring you find. (After this lesson, students can make individual books with their journal pages. Mimic the page set up of I Went Walking by Sue Williams.)*

Activity: Let's graph the signs of spring in our garden!

- Facilitate the students making a bar graph on the lined chart paper. Include the title of the graph as well as labels on the x and y axes. *Post-it notes, while an added expense, will be faster in making the graph rather than having the class wait while a student colors the bar in marker.

Let's Review

Question: Which sign of spring did you find the most of? The least?

- Ask other questions incorporating the terms more than and less than.

Keep Exploring

- Make a class book from the images taken at the beginning of the lesson.
- Books about spring:
 - Beskow, Elsa Maartman. *Around the Year*. Floris Books, 1988.
 - Blackstone, Stella. *Skip Through the Seasons*. Barefoot Books, 2007.
 - Fowler, Allan. *How Do You Know It's Spring?* Children's Press, 1991.
 - Gibbons, Gail. *The Reasons for Seasons*. Holiday House, 1996.
 - Glaser, Linda. *It's Spring!* Millbrook Press, 2002.
 - Good, Elaine W. *That's What Happens When It's Spring!* Good Books, 1969.
 - Lenski, Lois. *Spring Is Here*. Random House, 2005.
 - Lin, Grace and McKneally, Ranida T. *Our Seasons*. Charlesbridge Publishing, 2007.
 - Muller, Gerda. *The Circle of Seasons*. Dutton Juvenile, 1995.
 - Raczka, Bob. *Spring Things*. Albert Whitman & Company, 2007.
 - Roca, Nuria. *Spring*. Barron's Educational Series, 2004.
 - Rockwell, Anne. *Four Seasons Make a Year*. Walker Books for Young Readers, 2004.
 - Schnur, Steven. *Spring: An Alphabet Acrostic*. Clarion Books, 1999.
 - Thompson, Lauren. *Mouse's First Spring*. Simon & Schuster, 2005.
 - Todor, Tasha. *Around the Year*. Simon & Schuster, 2001.

27. Signs of Spring-K

Name _____ Date _____

Draw your signs of spring below:

<p>I went walking. What did you see?</p>	<p>I saw _____ looking at me.</p>
--	---------------------------------------

<p>I went walking. What did you see?</p>	<p>I saw _____ looking at me.</p>
--	---------------------------------------

**I went walking.
What did you see?**

**I saw _____
looking at me.**

**I went walking.
What did you see?**

**I saw _____
looking at me.**

Cover pages for kindergarten journal books:

I Went Walking

By _____

I Went Walking

By _____

28. Pound That Plant! Designs with Plant Pigments

Objective: Students explore pigments in their own bodies as well as in plants.

- Recognize the physical and human characteristics of their surroundings.
- Understand most objects are made of parts.
- Gain awareness that pigmentation is a part of plant structure.

Materials

- Journal page (one per student)
- Clipboard
- Crayons
- 100% cotton fabric or watercolor paper
- Wide painters tape or masking tape (several rolls for students to share)
- Hammers or flat rocks (1 per pair of students)
- Stacks of newspaper
- Paper towels or rags



Preparation

- Print a journal page for each student.
- Cut watercolor paper to be the size of a greeting card or cut fabric to an 8 x 8 square. (Fabric can be a sheet from Deseret Industries that has been washed and dried.)
- Test plant pieces from the garden so you know a few that are guaranteed to work. Make a demonstration square.

Procedure

***Question:** What is a pigment? (A pigment is any substance whose presence in the tissues or cells of animals or plants colors them.) Do people have pigments? (Yes! It is what colors our skin, hair, and eyes.)*

***Engage!** A spectrum of people pigments (melanin).*

- Have students hold out their forearms in front of themselves.
- Students should work together to make a spectrum of the lightest forearms to the darkest.
- Ask students what colors they see.

***Question:** Do plants have pigments too? (Yes! In many more colors too.)*

Activity: *Plant pigment survey.*

- Hand each student a journal page, clipboard, and several crayons.
- Provide a big container with more crayons so students can trade colors if needed.
- Allow students time in the garden to fill out their journal pages.

Question: *What colors did you find? What makes those colors? (pigments)*

Activity: *Plant Poundings! (Demonstrate each of the steps below.)*

- Have students go back into the garden in pairs to pick flowers and leaves. They should only pick something if there will be three or more left. (Remind them of the 2-hand picking rule!) Show them a few examples and suggest good areas to look.
- Students should remove any bulky plant pieces so the leaves and flower petals can lay flat against the material.
- Pieces should be placed face down on the cloth or fabric then taped to keep them in place. Tape edges should match rather than overlap so that seams are not created through the plant pounding designs.
- Fabric should be flipped over onto a stack of newspapers on the cement or asphalt playground. (Watercolor paper does not need to be flipped over but should also be placed on newspaper.)
- Students should **gently** tap the fabric (if using cotton) or tape (if using watercolor paper) with a hammer or rock so the pigment of the plant is imprinted on the material. If students pound too vigorously, they will be left with blobs of mushy, brown color rather than imprints of the flower pieces. (Partners can help hold the fabric or paper as well as monitor the gentle tapping.)
- If using fabric, provide paper towels or rags so students can wipe the hammer or rock in between each plant piece. This will encourage a cleaner, crisper end result.
- Once the pounding is finished, remove the tape and plant pieces from the material.



Tips from davesgarden.com:

- Flowers that work particularly well for this include phlox florets, single roses or rose petals, single impatiens, pansies with as much of the back removed as possible without destroying the flower (this takes some practice), hardy geraniums, St. Johns Wort, Forget-me-nots, any flower that can be flattened without losing the integrity of the bloom.
- The best time to pick the flowers is after the dew has dried, but before the heat of the day.
- New blooms have more color than older.
- Newer leaves pound much better than older, although as they age, you get the veins and edges that can be interesting.

- Not all flowers are suitable for pounding. Flowers with particularly thick petals such as tulips don't work well as they tend to smear. Flowers with many petals such as roses need to be taken apart so that you can pound the petals individually. Daisy-like blooms need to have their centers removed and all flowers need to have stems, calyxes, pistils and stamens removed.
- White flowers don't work as they have no pigment to impart to the fabric.

Let's Review

- *What are pigments?*
- *What are they used for?*
- *Where can you find them?*

Keep Exploring













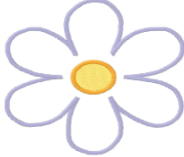

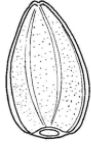



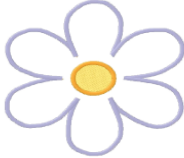

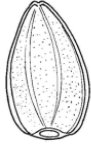



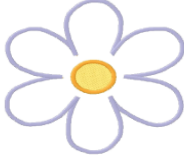

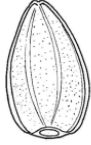



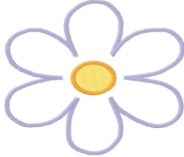

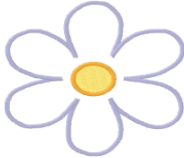

- If watercolor paper was used, write a letter or card to someone.

28. Pound That Plant!-K

Name _____ Date _____

Plant Pigment Survey

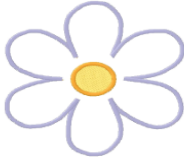
Use a crayon to fill in the square with the color you found in the garden. Circle the part of the plant you found that color on.

Color:	Plant Part:				
	 stem	 leaf	 flower	 fruit	 seed
	 stem	 leaf	 flower	 fruit	 seed
	 stem	 leaf	 flower	 fruit	 seed
	 stem	 leaf	 flower	 fruit	 seed
	 stem	 leaf	 flower	 fruit	 seed
	 stem	 leaf	 flower	 fruit	 seed

Objective: Understand connections in the natural world.

- Practice using the senses of hearing, smelling, and feeling outdoors
- Use logical and organized thinking

*Note: This activity would be easier with two adults, if possible.

Materials

- Long cord or rope (40-75 feet) The length will depend on the area that you will be using.
- Short piece of rope or cord (2-3 feet) with a knot tied in it.
- A twig, rock, fragrant leaf, or other object from outside for the Practice Run (see below).
- White board and marker
- Blindfolds for each student (bandanas, pieces of cloth)
- A clipboard with a blank sheet of paper and a pencil

**Preparation**

- Go out to the garden area or school ground area that would make an interesting and safe course for sensory exploration.
- Create a course with multiple levels and with objects captivating to feel, smell, or hear. For instance, the rope can go along the ground so that they can feel particular plants, rocks, or other things along the way, then go up into a bush or low tree, and so on.
- Put knots in the rope before a particularly compelling object comes up so that they will know to slow down and really feel around. Find at least 5-6 (or more) objects. There could be an interesting texture, perhaps a scent that will be released by rubbing, or some seedpods that rattle. Observe carefully and get creative!
- Put the short rope with the knot, the blindfolds, and the “Practice Run” objects at the front of the room.

Procedure

Have the students sit in a circle on the floor.

You have done a lot of exploring in the garden with your eyes, but not as much with your hands, noses, and ears. Today we'll explore the garden and schoolyard by covering our eyes and using our other senses! Nobody will get lost, as we will all be connected by holding onto a rope. After our adventure, I'd like to get some ideas from you about some other connections outside too. Back to that later!

Practice Run

- Have one student come to stand with you in the front of the room and give him or her the short rope.
- Show the blindfolds then tie yours on.
- Have the student hold one end of the short rope and hand you the other end.
- Show that they will keep their hands on the rope, moving carefully along until running into a knot. At the knot, carefully feel around for your objects and spend some time feeling, smelling and shaking the objects. Let them know that there is no peeking or the game won't be as fun!
- Take off your blindfold and hand one to each student to put on. Pass around the rope and one of your objects so that they can get the feel for what they will be doing outside.
- Have them take off the blindfolds and keep them to take outside.

Outside Adventure:

- Take out the blindfolds, clipboard, paper, pencil, white board, marker, and the short rope.
- Have the students sit in a circle outside close to the beginning of the course so that you can explain the rules.
 - Again show the rope and explain that each time they feel a knot they will feel extra carefully around the area for something to explore with their senses and to try and figure out what it is.
 - No letting go of the rope, no peeking, and no tasting!
 - Show that the rope will go down sometimes (they will need to squat and walk) and up sometimes.
 - This is a silent walk too so that they can really concentrate and not spoil the surprises along the way for other students. Students may however, help their classmates with verbal cues such as, "Duck under the branch I'm under," or "Be careful not to trip on the rock to the left!"
 - Explain that when each person finishes the course, they will quietly remove their blindfold and join their group at the end of the course next to a clipboard.
 - When the whole group is present, they will sit down and share what they found. Have them talk about what they think the special objects or areas might be, how things felt, sounded, or smelled, and any other miscellaneous thoughts.
 - They will stay seated with their group until everyone has finished. You will allow the last group finishing a few minutes to talk about their ideas too.
- After going over the rules, line up everyone at the beginning of the course in order of their classroom groups and have them put on their blindfolds.
- The students start along the course one at a time. So that they will be more comfortable, help each one along the first few yards (perhaps to the first knot) and then go back for the next one. It would be handy, but not essential to have another adult help them as they go through the course and to help them get settled into their groups when done.
- When everyone has finished, spend some time with the whole class sharing what they have found.
- Line them up again and have them go through the course with their eyes uncovered to have a look at everything. They will probably be surprised at many of the things!

In this adventure you were all connected to plants and other objects and to each other with a rope. Let's look at some of the areas around the knots on the rope and see if we can figure out how those objects and other things in nature are also all connected.

- Go to the first area and have the students sit in a circle or semi-circle around the item (rock, bush, leaves, etc.)
- The class will play a word association game. Explain that you will say the name of the object and then start going around the circle with each person saying something that is related such as what the plant, etc. needs to survive, what in nature needs or uses that object, or how it can be used. No repeats! You will probably need to do a bit of prompting as they may not know about many of the connections in nature.
- Keep track of the associations on the white board. Here's an example:
leaf→tree→bird→worm→soil→rocks→centipede→and so on!
- If the students would like another challenge, after going around the circle, choose another object from the course, the garden, or elsewhere outside. The students will find this game fairly challenging, but a lot of fun. They will start to understand the big picture.
- When you run out of room on the board, you can continue onto paper. Gather up everything and return to the classroom. Hang up the "connection lists" to display.

Let's Review

- *What senses did you use today?*
- *What sense helped you the most to figure out what an object was?*
- *What was the most surprising thing that you felt along the way on your rope walk?*

Keep Exploring

- Read some books about ecosystems and the connections in nature and the garden.

29. Making Connections-K

Name _____ Date _____

Color the Ladybug and all of her connections!

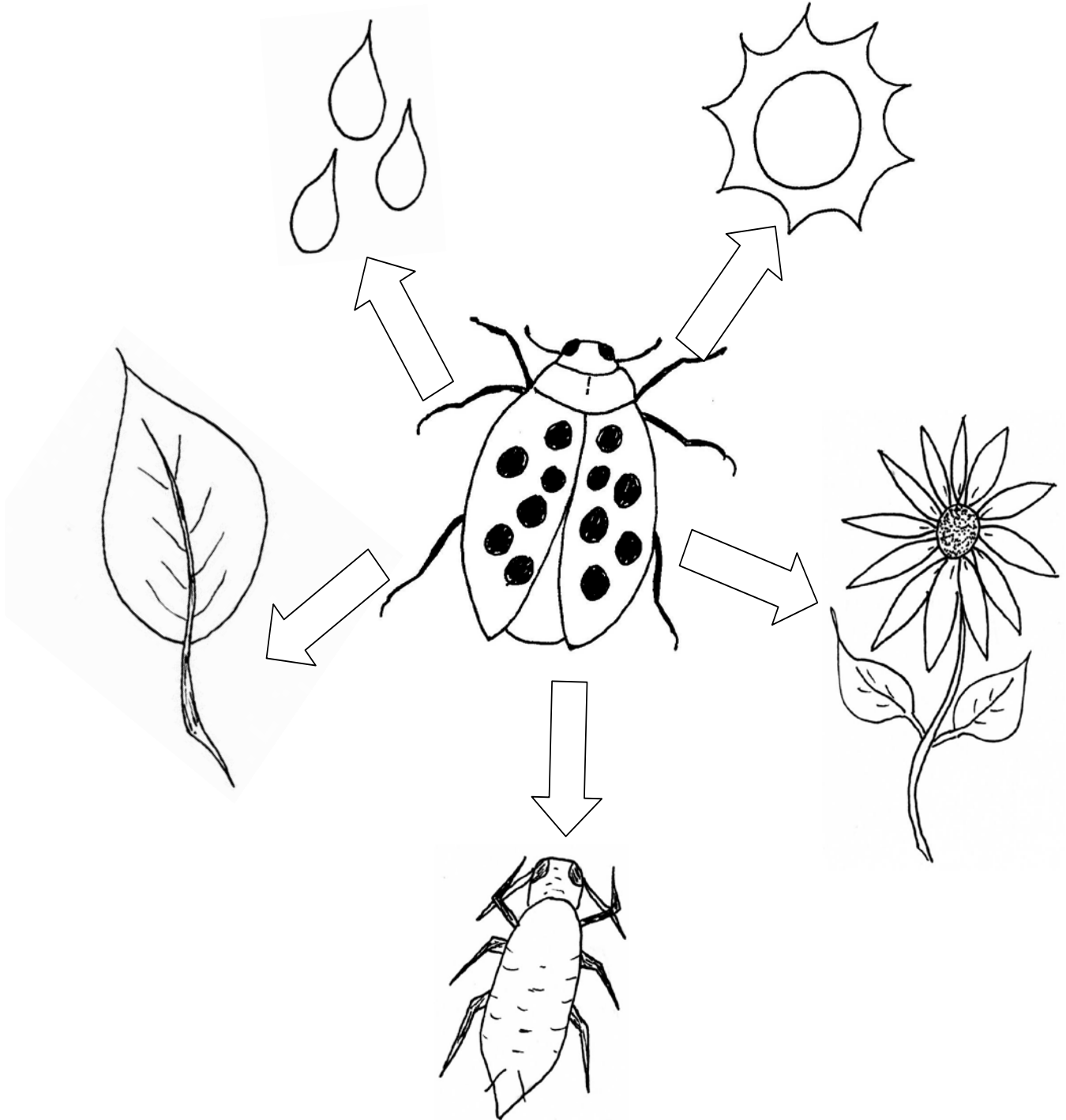

Objective: Students will learn about the process of pollination through the perspective of bees and will plant a pollinators' garden.

- Understand most objects are made of parts.
- Identify change happens to many things.
- Realize some changes are so slow they are hard to see.

Materials

- Squash bee and honey bee picture cards (attached)
- Clothes pins (one for each student)
- Male pumpkin flower pictures (7)
- Female pumpkin flower pictures (3)
- Pumpkin fruit pictures (3)
- Dixie cups (10 per student)
- Juice
- Yellow, craft pom poms (7 per student)
- A Bee's Eye View pictures (attached)
- Flowers the students grew in lesson 23
- Additional plants from a nursery or garden store (optional), see host plants and nectar plants listed in "Butterfly Species Most Likely to Find in Your Salt Lake County Yard" handout (attached)



Preparation

- Print the pumpkin flower pictures (7 male and 3 female) on yellow paper. Laminate. Place in 10 different spots in the garden.
- Pour ~1 tablespoon juice in each paper cup. Place one for each student with each flower.
- Place one pom pom for each student in the center of the male flower pictures only.
- Print the pumpkin fruit pictures.
- Print and cut the squash and honey bee pictures.
- Print the bee's eye view pictures. Cut each flower type apart (i.e. dandelion, evening primrose, or spring crocus). Fold each flower type in half so that the students will see the human view first and the bee's view second.

Procedure

Engage! Let's be pollinators!

- Give each student a squash bee or honey bee picture to clothes pin to their shirt.
- Split the class so they are starting in two different areas of the garden.
- As bees who want nectar, students should find the 10 flowers you have hidden around the garden.

- Once a flower is found, the “bee” should drink one cup of “nectar” and take one pom pom (i.e. piece of pollen) from the flower. If there isn’t pollen on the flower, the bee should drink his/her nectar, keep the cup, and find the next flower.
- Students should keep the empty cups with them so they can keep count of how many flowers they have found (10).
- Once a “bee” reaches another flower, the “pollen” from the previous flower (if there was one) should be traded with “pollen” from the new flower. If there isn’t pollen at the new flower, drop off the piece of pollen, drink the nectar, and move on to the next flower.
- Once all bees have drunk their nectar and pollinated all 10 flowers, they should return to the big group.

Question: *Who are pollinators? What is their job? Why are they important?*

- *Who?* There are an estimated **200,000** different species of pollinators! 1,000 are vertebrates. Check the “Know Your Pollinators” handout (attached) for more info.
- *What?* To pollinate! Pollination is the transfer of pollen grains from the anther to the stigma of the same or another flower. In this case, the pumpkin flowers, the pollen from the male flowers is needed to go to the female flowers to make pumpkins.
- *Why?* Pollinators are responsible for 1 out of every 3 bites of food you take! About three-quarters of the world's flowering plants and at least 90 food crops eaten in North America depend on pollinators. A world without pollinators would be a world without apples, blueberries, strawberries, chocolate, almonds, melons, peaches, pumpkins, and many more!

Activity: *Let’s go see if our flowers are pollinated! At the beginning of our game only the boy flowers had the pollen. As you bees drank your nectar you also picked up pollen. When you went to a new flower for more nectar, you gave pollen and took pollen. If our girl flowers ended up with pollen at the end of our game, they were pollinated and will make pumpkins!*

- Bring the 3 pumpkin pictures.
- Have students show you the different flowers they found.
- Determine whether the flower is male (long stem) or female (shorter stem with ovary).
- If the flower is male, go to another flower.
- If the flower is female, check to see if bees left behind any pollen. If there is pollen, replace the flower with a pumpkin picture.
- Congratulate the bees on a job well done!

Question: *What color are the pumpkin flowers you visited today? (yellow) Did you know that bees looking at the same flowers might not see any yellow at all?*

- One by one, show the bee’s eye view flowers.
- Let students know bees are able to see a broader spectrum of light than people. They are able to see UV light. That is why the same flowers can look different to bees than us.

Question: *Why do you think that would be important to bees? (It helps them get to the nectar. The stripes are like landing strips. The spots are like the bulls-eye of a target.)*

Activity: *Planting a pollinators’ garden. We’ve learned how pollination works and why it is important. Let’s plant a garden that will attract as many pollinators as possible. We’ll start*

with the flowers YOU grew in our classroom! (optional: add nursery seedlings as well) Let's create a pattern with the different flowers we grew.

Here are a few tips from <http://www.fs.fed.us/wildflowers/pollinators/gardening.shtml>:

- 1. Use a wide variety of plants that bloom from early spring into late fall.**
Help pollinators find and use them by planting in clumps, rather than single plants. Include plants native to your region. Natives are adapted to your local climate, soil, and native pollinators. Night-blooming flowers will support moths and bats.
- 2. Avoid modern hybrid flowers, especially those with “doubled” flowers.**
Often plant breeders have unwittingly left the pollen, nectar, and fragrance out of these blossoms while creating the “perfect” blooms for us.
- 3. Include larval host plants in your landscape.**
If you want colorful butterflies, grow plants for their caterpillars. They WILL eat them, so place them where unsightly leaf damage can be tolerated. Accept that some host plants are less than ornamental if not outright weeds. A butterfly guide will help you determine the plants you need to include.
- 4. Create a damp salt lick for the butterflies and bees.**
Place your bird bath on bare soil to create a damp area. Mix a small bit of table salt (sea salt is better!) or wood ash into the mud.
- 5. Butterflies need resources other than nectar.**
They are attracted to unsavory foodstuffs, such as moist animal droppings, urine and rotting fruits. Try putting out slices of overripe bananas, oranges and other fruits, or a sponge in a dish of lightly salted water to see which butterflies come to investigate. Sea salt provides a broader range of micronutrients than regular table salt.

Let's Review

Question: Who are pollinators? What is their job? Why are they important? Why did we plant a garden for them?

Keep Exploring

- Have students watch for pollinators and create their own field guides.
- Try to identify the butterflies visiting the school garden. Use the “All Butterflies Sighted Within Salt Lake County” list (attached) as a beginning step.
- Observe the visiting pollinators. Are there preferred flowers? Colors? Shapes?
- Check for pupa in the garden. Which butterfly will emerge?
- Are there other pollinators visiting in addition to the butterflies and bees?

30. Thank You, Pollinators!-K

Name _____ Date _____

Draw a flower and a pollinator.

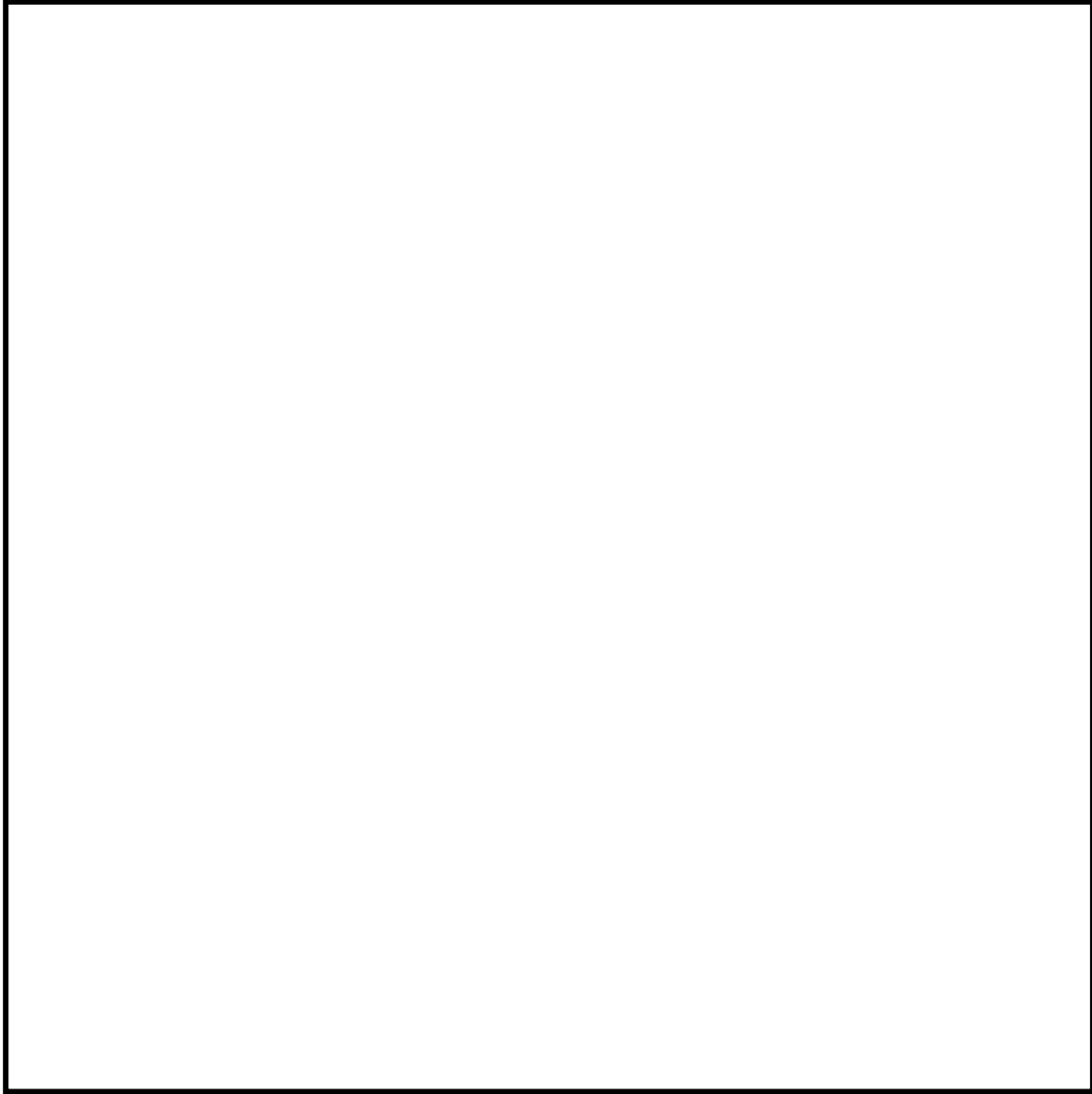

Why does this pollinator like this flower? _____

Male Pumpkin Flower

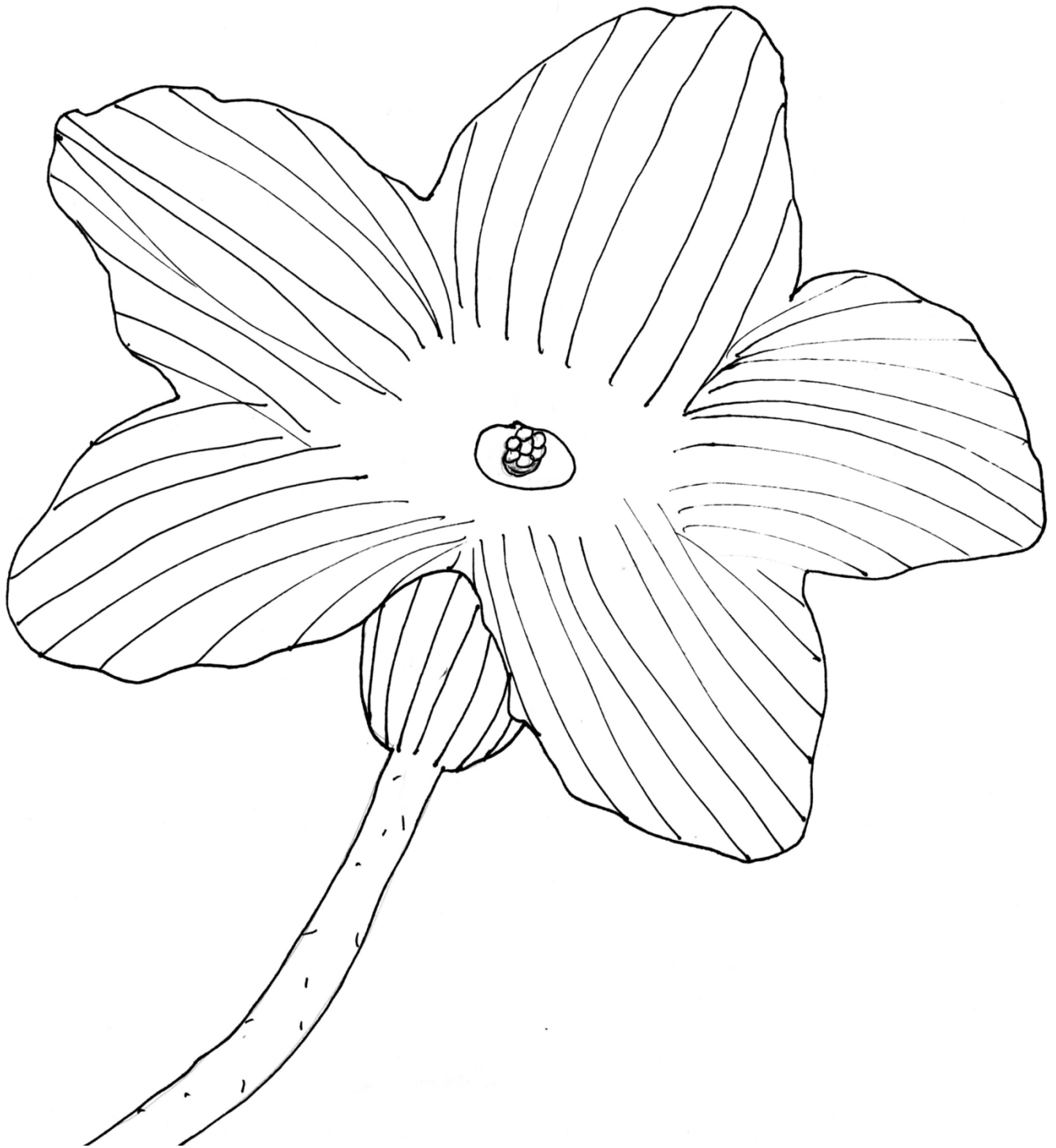

Female Pumpkin Flower

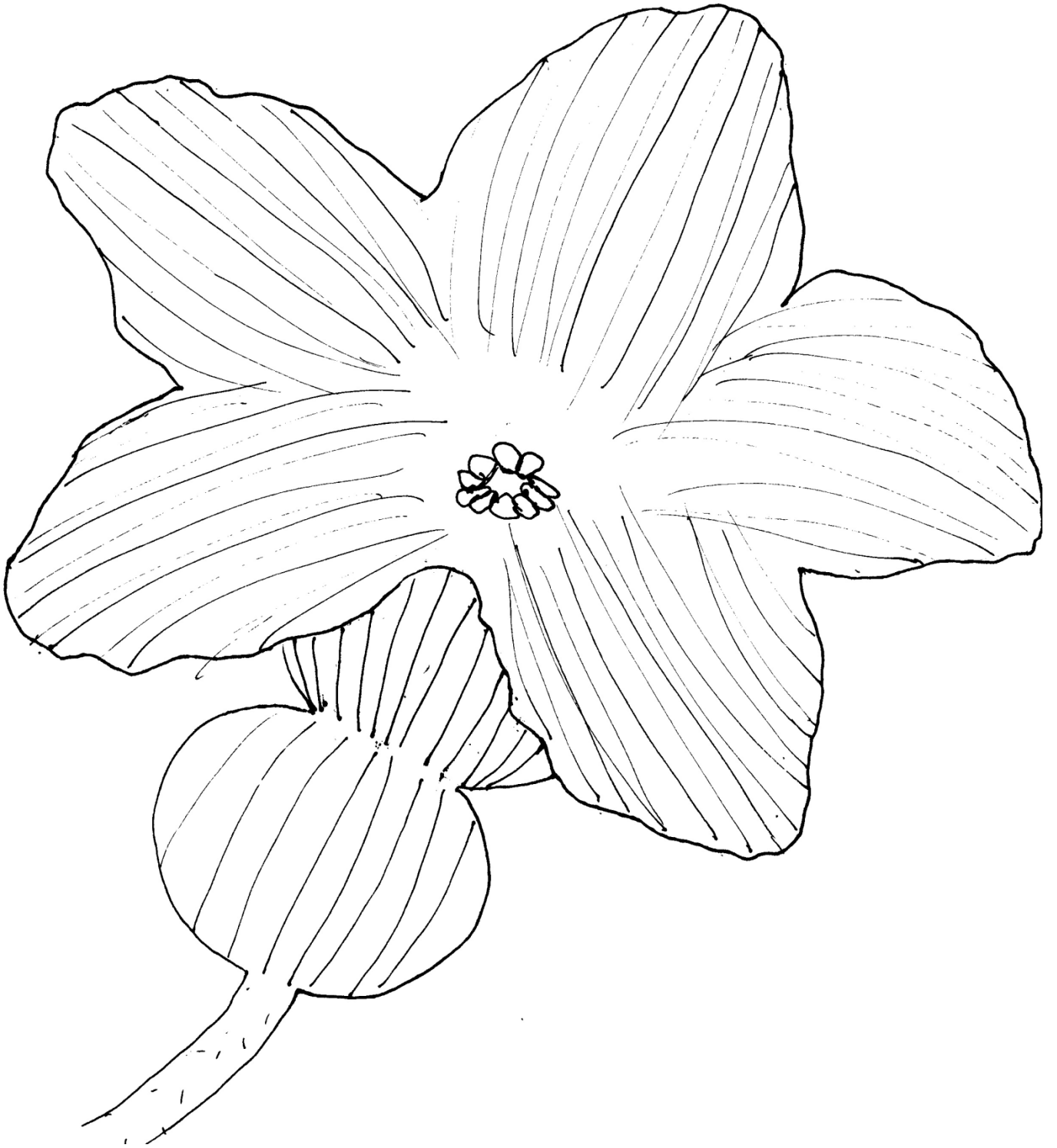



Squash Bee



Squash Bee



Squash Bee



Squash Bee



Honey Bee



Honey Bee



Honey Bee



Honey Bee



Honey Bee



Honey Bee



A Bee's-Eye View

The picture on the left shows the flower as a human sees it. The photo on the right is the bee's-eye view that has a broader, UV spectrum of light. Images were taken by Norwegian scientist-cameraman, Bjorn Roslett.

Evening primrose (*Oenothera biennis*)



Wood anemone (*Anemone nemorosa*)



Dandelion (*Taraxacum officinale*)







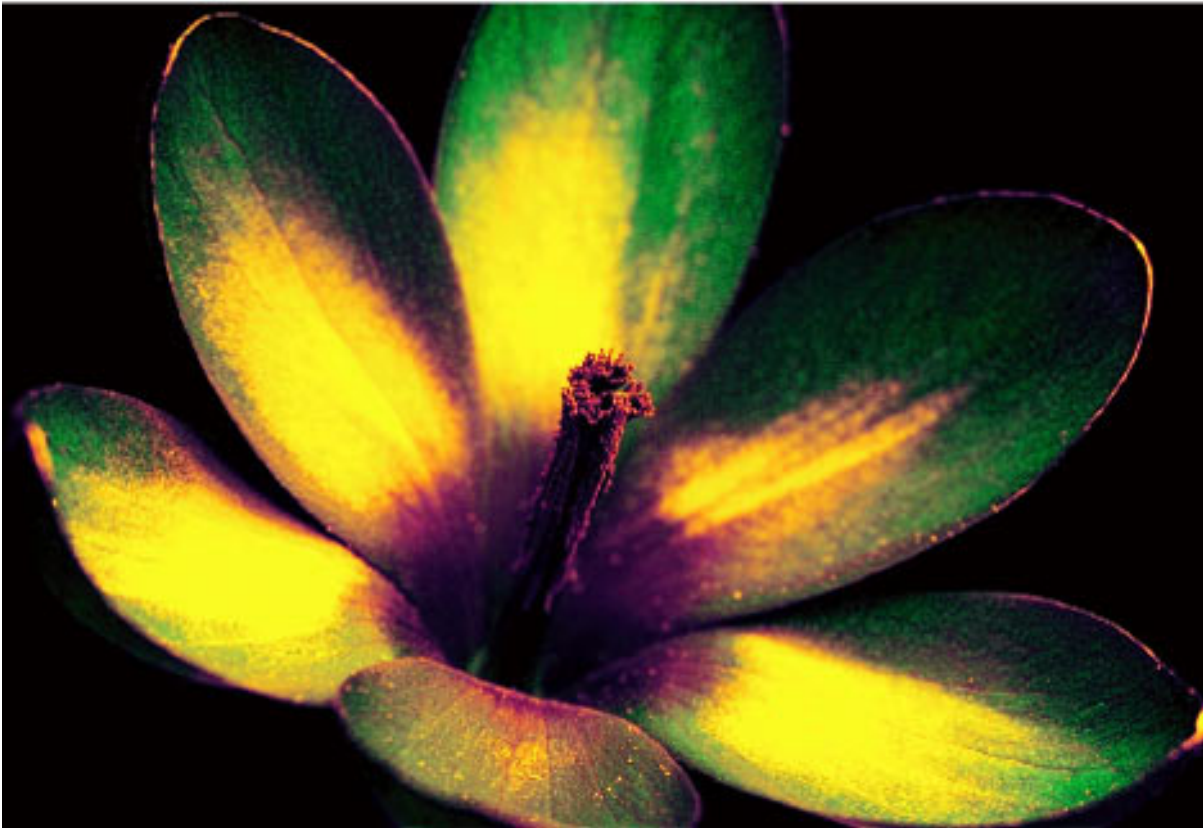

Silverweed (*Potentilla anserina*)



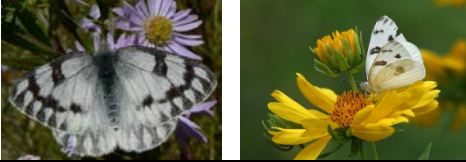

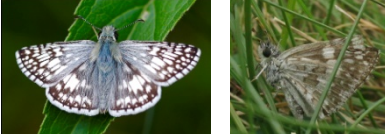

Spring crocus (*Crocus vernus*)

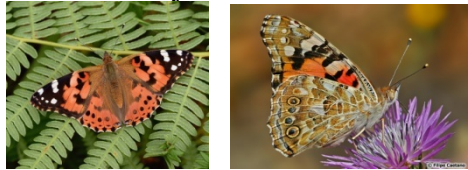
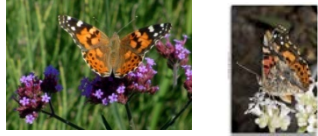

Butterfly Species Most Likely to Find in Your Salt Lake County Yard

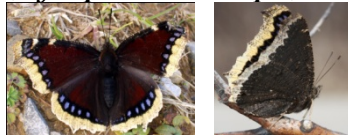
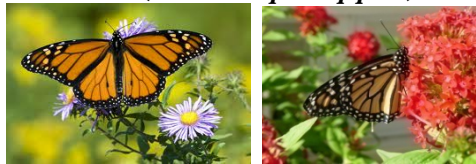
Species:	Host plants (larva stage):	Nectar plants (butterfly):
Checkered White (<i>Pieris protodice</i>) 	Cabbage Kale Collards	Hedge mustards Alfalfa
Cabbage White (<i>Pieris rapae</i>) 	Cabbage Kale Collards Nasturtium	Asters Mint Mustard Dandelion Red clover
Clouded Sulphur (<i>Colias philodice eriphyle</i>) 	Plants in the pea family Alfalfa White Clover	Clover Milkweed Goldenrod Asters Sunflowers Dandelions
Gray Hairstreak (<i>Strymon melinus franki</i>) 	Pea family Mallow Beans Clover	Mint Milkweed Goldenrod White sweet clover Winter cress Dogbane
Western Pygmy-Blue (i) 	Pigweed Saltbush Goosefoot	Asters Goldenrod Rabbitbrush
Common Checkered-Skipper (<i>Pyrgus communis</i>) 	Globemallow Mallow Hollyhock	Asters Red clover Shepherd's needles Fleabane
Juba Skipper (<i>Hesperia juba</i>) 	Slender hairgrass Needlegrass Foxtail brome Bluegrass	Rabbitbrush

<p>Sandhill Skipper (<i>Polites sabuleti sabuleti</i>)</p> 	<p>Bermuda Grass Bluegrass</p>	<p>Asters Rabbitbrush Heliotrope</p>
<p>Painted Lady (<i>Vanessa cardui</i>)</p> 	<p>Hollyhock Legumes Mallow Thistles</p>	<p>Aster Cosmos Blazing star Joe-pye weed Thistles Milkweed</p>
<p>West Coast Lady (<i>Vanessa carye annabella</i>)</p> 	<p>Tree mallow Globe mallow Bush mallow Alkali mallow Checkerbloom Hollyhock</p>	<p>Nectar from a wide variety of flowers.</p>
<p>Red Admiral (<i>Vanessa atalanta rubria</i>)</p> 	<p>Hops Nettle</p>	<p>Prefer sap flow on trees, fermenting fruit, bird droppings. Then will go to asters, alfalfa, red clover, and milkweed.</p>
<p>Mourning Cloak (<i>Nymphalis antiopa</i>)</p> 	<p>American elm Aspen Cottonwood Willow</p>	<p>Prefer tree sap of oaks and rotting fruit. Occasionally on flower nectar.</p>
<p>Monarch (<i>Danaus plexippus</i>)</p> 	<p>Milkweed</p>	<p>Milkweed Dogbane Lilacs Goldenrods Blazing stars Ironweed</p>
<p>Two-tailed Swallowtail (<i>Papilio multicaudata pusillus</i>)</p> 	<p>Trees: Ash Hop Chokecherry</p>	<p>Milkweed Lilac Thistles California Buckeye</p>

All Butterflies within Salt Lake County

Hesperiidae - Skippers

[*Epargyreus clarus*](#) Silver-spotted Skipper
[*Thorybes pylades*](#) Northern Cloudywing
[*Thorybes mexicana*](#) Mexican Cloudywing
[*Erynnis icelus*](#) Dreamy Duskywing
[*Erynnis brizo*](#) Sleepy Duskywing
[*Erynnis telemachus*](#) Rocky Mountain Duskywing
[*Erynnis afranius*](#) Afranius Duskywing
[*Erynnis persius*](#) Persius Duskywing
[*Pyrgus ruralis*](#) Two-banded Checkered-Skipper
[*Pyrgus scriptura*](#) Small Checkered-Skipper
[*Pyrgus communis*](#) Common Checkered-Skipper
[*Heliopetes ericetorum*](#) Northern White-Skipper
[*Pholisora catullus*](#) Common Sootywing
[*Piruna pirus*](#) Russet Skipperling
[*Oarisma garita*](#) Garita Skipperling
[*Hesperia uncas*](#) Uncas Skipper
[*Hesperia juba*](#) Juba Skipper
[*Hesperia colorado*](#) Western Branded Skipper
[*Polites sabuleti*](#) Sandhill Skipper
[*Polites draco*](#) Draco Skipper
[*Polites themistocles*](#) Tawny-edged Skipper
[*Ochlodes sylvanoides*](#) Woodland Skipper
[*Ochlodes yuma*](#) Yuma Skipper
[*Poanes taxiles*](#) Taxiles Skipper

Papilionidae-Parnassians &

Swallowtails

[*Parnassius clodius*](#) Clodius Parnassian
[*Parnassius smintheus*](#) Rocky Mtn. Parnassian
[*Papilio machaon*](#) Old World Swallowtail
[*Papilio zelicaon*](#) Anise Swallowtail
[*Papilio indra*](#) Indra Swallowtail
[*Papilio rutulus*](#) Western Tiger Swallowtail
[*Papilio eurymedon*](#) Pale Swallowtail
[*Papilio multicaudata*](#) Two-tailed Swallowtail

Lycaenidae - Gossamer-wing Butterflies

[*Lycaena arota*](#) Tailed Copper
[*Lycaena editha*](#) Edith's Copper
[*Lycaena rubidus*](#) Ruddy Copper
[*Lycaena heteronea*](#) Blue Copper
[*Lycaena helloides*](#) Purplish Copper
[*Lycaena nivalis*](#) Lilac-bordered Copper
[*Hypaurotis crysalus*](#) Colorado Hairstreak
[*Callophrys affinis*](#) Western Green Hairstreak
[*Callophrys sheridanii*](#) Sheridan's Green Hairstreak
[*Callophrys gryneus*](#) Juniper Hairstreak
[*Callophrys spinetorum*](#) Thicket Hairstreak
[*Callophrys augustinus*](#) Brown Elfin
[*Satyrium titus*](#) Coral Hairstreak
[*Satyrium sylvinus*](#) Sylvan Hairstreak
[*Satyrium saepium*](#) Hedgerow Hairstreak
[*Satyrium behrii*](#) Behr's Hairstreak
[*Strymon melinus*](#) Gray Hairstreak
[*Leptotes marina*](#) Marine Blue
[*Brephidium exilis*](#) Western Pygmy-Blue
[*Cupido amyntula*](#) Western Tailed-Blue
[*Celastrina ladon*](#) Spring Azure
[*Glaucopsyche piasus*](#) Arrowhead Blue
[*Glaucopsyche lygdamus*](#) Silvery Blue
[*Euphilotes battoides*](#) Western Square-dotted Blue
[*Euphilotes ancilla*](#) Rocky Mountain Dotted-Blue
[*Euphilotes spaldingi*](#) Spalding's Dotted-Blue
[*Echinargus isola*](#) Reakirt's Blue
[*Plebejus idas*](#) Northern Blue
[*Plebejus melissa*](#) Melissa Blue (includes Karner Blue)
[*Plebejus saepiolus*](#) Greenish Blue
[*Plebejus icarioides*](#) Boisduval's Blue
[*Plebejus lupini*](#) Lupine Blue

Nymphalidae - Brush-footed

Butterflies

[*Danaus plexippus*](#) Monarch
[*Danaus gilippus*](#) Queen
[*Euptoieta claudia*](#) Variegated Fritillary
[*Speyeria cybele*](#) Great Spangled Fritillary
[*Speyeria coronis*](#) Coronis Fritillary
[*Speyeria zerene*](#) Zerene Fritillary
[*Speyeria callippe*](#) Callippe Fritillary
[*Speyeria egleis*](#) Great Basin Fritillary
[*Speyeria hydaspe*](#) Hydaspe Fritillary
[*Speyeria mormonia*](#) Mormon Fritillary
[*Boloria selene*](#) Silver-bordered Fritillary
[*Limenitis weidemeyerii*](#) Weidemeyer's
Admiral
[*Chlosyne gorgone*](#) Gorgone Checkerspot
[*Chlosyne acastus*](#) Sagebrush Checkerspot
[*Chlosyne palla*](#) Northern Checkerspot
[*Phyciodes pallida*](#) Pale Crescent
[*Phyciodes mylitta*](#) Mylitta Crescent
[*Phyciodes cocyta*](#) Northern Crescent
[*Phyciodes batesii*](#) Tawny Crescent
[*Phyciodes pulchella*](#) Field Crescent
[*Euphydryas chalcedona*](#) Chalcedon
Checkerspot
[*Junonia coenia*](#) Common Buckeye
[*Polygonia satyrus*](#) Satyr Comma
[*Polygonia faunus*](#) Green Comma
[*Polygonia gracilis*](#) Hoary Comma
[*Polygonia progne*](#) Gray Comma
[*Aglais milberti*](#) Milbert's Tortoiseshell
[*Nymphalis vaualbum*](#) Compton
Tortoiseshell
[*Nymphalis antiopa*](#) Mourning Cloak

[*Nymphalis californica*](#) California
Tortoiseshell
[*Vanessa atalanta*](#) Red Admiral
[*Vanessa cardui*](#) Painted Lady
[*Vanessa annabella*](#) West Coast Lady
[*Vanessa virginiensis*](#) American Lady
[*Coenonympha tullia*](#) Common Ringlet
[*Neominois ridingsii*](#) Ridings' Satyr
[*Oeneis chryxus*](#) Chryxus Arctic
[*Cercyonis pegala*](#) Common Wood Nymph
[*Cercyonis sthenele*](#) Great Basin Wood
Nymph
[*Cercyonis oetus*](#) Small Wood Nymph

Pieridae - Whites and Sulphurs

[*Anthocharis stella*](#) Stella Orangetip
[*Euchloe ausonides*](#) Large Marble
[*Euchloe lotta*](#) Desert Marble
[*Pieris marginalis*](#) Margined White
[*Pieris rapae*](#) Cabbage White
[*Pontia beckerii*](#) Becker's White
[*Pontia protodice*](#) Checkered White
[*Pontia occidentalis*](#) Western White
[*Pontia sisymbrii*](#) Spring White
[*Colias philodice*](#) Clouded Sulphur
[*Colias eurytheme*](#) Orange Sulphur
[*Colias occidentalis*](#) Western Sulphur
[*Colias alexandra*](#) Queen Alexandra's
Sulphur
[*Zerene cesonia*](#) Southern Dogface
[*Anteos clorinde*](#) White Angled-Sulphur
[*Abaeis nicippe*](#) Sleepy Orange
[*Nathalis iole*](#) Dainty Sulphur

Riodinidae - Metalmarks

[*Apodemia mormo*](#) Mormon Metalmark

*information from:

<http://www.butterfliesandmoths.org>

Know Your Pollinators...

Pollinator	Fun Facts	Status	Favorite Flowers
Bees	There are more than 4,000 native bee species in the U.S.	Certain populations, especially the honeybee in the U.S. and bumble bees in the U.S. and U.K, are in decline. But our knowledge of most of the 30,000 bee species worldwide is limited because most populations have not been monitored over time. <u>Learn more about why bees might be dying and how the decline in bee abundance could affect our world...</u>	Bees prefer blue or yellow flowers and those that are sweet-smelling.
Butterflies	Butterflies taste with their feet!	Scientists have observed significant declines in the diversity of butterfly species in some areas of the U.S. over the past 30 years.	Butterflies like flowers that are red, yellow, or orange. Scent doesn't matter; butterflies rely more on vision and less on scent to find nectar.
Hummingbirds	To survive, many hummingbirds must eat twice their body weight in nectar each day!	Hummingbird populations appear to be stable or rising for some species, while a few species appear to be declining slightly.	Hummingbirds are attracted to red, orange, or yellow flowers. Like most birds, hummingbirds do not have a highly developed sense of smell, so flower scent doesn't matter.
Bats	Some bats migrate 1,000 miles or more every spring from Mexico into the southwestern U.S. Most flower-visiting bats are found in Africa, Southeast Asia, and the Pacific Islands.	Three pollinating bats, including <i>Leptonycteris curasoae</i> and <i>L. nivalis</i> are threatened or endangered in the U.S. and Mexico. The cause of their decline appears to be destruction of critical cave roosting areas due to tourism and agricultural development.	Bats like flowers that are large and white or pale in color. Some bat-pollinated flowers are open only at night and typically have a fermented, fruity, or musky scent.
Moths	What's the difference between moths and butterflies? Generally, moths fly at night and have antennae with all kinds of shapes whereas butterflies fly during the day and have knobs on the ends of their wiry antennae.	There have been no published studies on population trends of pollinating moths, but several moths are on state or federal endangered species lists.	Moths are attracted to sweet-scented flowers that are typically large and white or pale in color. Some moth-pollinated flowers are open only at night.

Flies	Small flies called midges are necessary for cocoa trees to bear the seed that is used to make chocolate!	There have been no published studies on population trends of pollinating flies, but one fly, the Delhi Sands flower-loving fly, is on the endangered species list in the U.S.	In tropical regions, flies are often found on pale, dark brown, or purple flowers that stink of dung or carrion. In temperate regions, they can be found on flowers of many colors, usually those that have easy access to nectar.
Wasps	Although California is among the leading fig producers in the world, figs could not be grown commercially until tiny fig wasps were imported to pollinate them. Watch out! Female wasps have stingers.	There have been no published studies on population trends of pollinating wasps.	Preferences unknown.
Beetles	Beetles are the oldest pollinators on earth and pollinate many of the most primitive flowering plants.	There have been no published studies on population trends of pollinating beetles.	Beetles are typically attracted to flowers that are white or green and have a wide opening.

<http://dels-old.nas.edu/pollinators/aboutpollinators.shtml>

A Few Lesser Known Pollinators:

1. Ants
2. Birds
3. Bush babies
4. Capuchin monkeys
5. Feathertail glider
6. Geckos
7. Gnats
8. Honey possums
9. Lemurs (largest known pollinator)
10. Lizards
11. Marsupial
12. Primates
13. Reptiles
14. Rodents
15. Skinks
16. Slugs
17. Stinkbugs
18. Sugar gliders
19. True bugs (Hemiptera)
20. Water
21. Wind

Planting Warm Weather Crops with Alternate Measurements

Objective: Students use their hand spans to create proper spacing when planting warm weather crops.

- Directly compare two objects with a measurable attribute in common, to see which object has “more of”/”less of” the attribute.
- Describe measurable attributes of objects in length.
- Solve addition and subtraction word problems.

Materials

- Rulers (inches)
- Journal pages
- Clipboards
- Pencils
- Tomato and pepper seedlings
- Tomato cages or other trellising material



Preparation

- Purchase tomato and pepper seedlings. Choose varieties that you and students would want to make salsa with in the fall. Wasatch Community Gardens (wasatchgardens.org) holds their annual plant sale with organically raised, heirloom varieties, 8am – 1pm, the Saturday of Mother’s Day weekend. You will find red, orange, yellow, green, purple, and striped tomatoes in all shapes and sizes! Another source for organic, heirloom varieties is Traces Inc. (1432 South 1100 East, 801-467-9544).
- Print journal pages for each student.

Procedure

Engage! Hand span line up.

- Tell students they are going to practice a method that farmers have been using for thousands of years. Farmers and gardeners have been using hand spans in their work for a long time!
- Spread your fingers and thumb to demonstrate your hand span.
- Have students hold up their own hand spans.
- To practice hand spans, have students compare hand spans with each other in order to make a shoulder-to-shoulder line that shows smallest hand span to the biggest.

Explore: Let’s practice measuring with hand spans.

- Choose a branch, leaf, vegetable, etc. to demonstrate measuring with your hand span(s).
- Give each student a journal page, clipboard, and pencil.

- Allow students to roam, in pairs, around the garden measuring things with their hand spans in order to complete their journal page.

Question: How do you think farmers and gardeners use hand spans in their work? (To estimate/measure space when planting, thinning, making new rows, etc.)

Activity: In order to estimate length with our hand spans more accurately, we are going to measure our hand spans with rulers.

- Place your hand/hand span on the back of a journal page.
- Trace your hand.
- Use a pencil and ruler connect the outermost points of your thumb and pinky with a straight line.
- Measure your hand span rounding to the nearest inch.
- Have students pair up to trace each other's hand spans on their own journal pages.
- Have one student volunteer to have his/her hand span measured as a demonstration.

Question: Next we are going to be planting tomatoes and peppers, warm season crops. If tomatoes need to be 18 inches apart, how many hand spans do you need between each plant? If peppers need to be 12 inches apart, how many hand spans do you need between each plant?

- The students' hand spans should be about the same size, especially if they are rounding to the nearest inch. Have students volunteer to demonstrate the proper number of hand spans for tomato and pepper spacing. Students can either write this number down or calculate the spacing using their own hand span measurements.

Activity: Let's plant!

- Students should plant their tomatoes and peppers using their hand span measurements.
- To fit more plants in a small space, stagger them in zig zag lines. There should still be 18 inches between each plant.
- Provide trellises for the tomatoes. It's easier now than when they are grown!

Let's Review

Question: Why use hand spans? (You always have your hands with you, you can measure space, plants will have proper spacing, etc.)

Keep Exploring

*From Math in the Garden, Hands-On Activities That Bring Math to Life

- Sing, "The Hand Span Song," by youth Kelsey Connolly. (attached)
- Brown Bag Secret – Hide a long vegetable like a zucchini in a brown bag. Tell children that the mystery vegetable is safe to touch. Pass the bag around so that everyone has a chance to reach in and feel the object. When they touch it, they are not to say what it is, rather they are to silently estimate how long it is in inches. After everyone has had a chance to estimate its length, ask what they think is in the bag. Reveal the object and ask a pair of children to measure it. How close were they in their estimates?

31. Hands Across the Garden – K

Name _____ Date _____

Explore the garden. Find spaces or objects for each of the hand spans below.
Draw or write what you found.

1 hand span	2 hand spans
3 hand spans	4 hand spans

Measure your hand span.

1. Spread your fingers and thumb as wide as they can go.
2. Place your hand span on the paper.
3. Have a friend use a pencil to trace your hand
4. Use a ruler to draw a straight line between the tip of your thumb and the tip of your pinky.
5. Use the ruler to measure the line of your hand span in inches.



1. My hand span is _____ inches long.
2. To plant tomatoes 18 inches apart, I will need _____ hand spans.
3. To plant peppers 12 inches apart, I will need _____ hand spans.

The Hand Span Song

By Kelsey Connolly

To the tune of "If You're Happy and You Know It"

Refrain:

If you want to measure something, use your hand span!

If you want to measure something, use your hand span!

Thumb and pinkie open wide.

It's an excellent measuring guide.

If you want to measure something, use your hand span!

If you want to plant some seeds in row, Go!

If you want to plant some seeds in row, Go!

Thumb and pinkie open wide,

with no ruler at your side.

You can use your hand span nicely in a row, Go!

Refrain

Do you see your green beans growing big and tall? Yea!

Do you see your green beans growing big and tall? Yea!

Use your handy measuring guide.

Thumb and pinkie open wide.

If you want to measure green beans, use your hands, Yea!

Refrain

32. Aha! We Found It! Using Coordinate Grids in the Garden

Objective: Students use coordinate grids to locate garden items.

- Recognize the physical characteristics of their surroundings.
- Model shapes in the world by drawing.

Materials

- 5 objects to hide in the garden (ex. unifix cubes, blocks, markers, etc.)
- Timer
- String or twine (A LOT of it if you make a giant grid)
- 2 colors of rolls of 2-inch wide tape
- 2 colors of markers that match the colors of the tape
- Black permanent marker
- 8 ½ x 11" coordinate grid (attached)
- Poster size coordinate grid
- Several stakes
- Yard stick
- 24 index cards
- Pencils (one per student)



Preparation

- Enlarge the 8 ½ x 11" coordinate grid to be poster size.
- Tie the string at regular intervals in a 10 x 10 grid. Use the stakes if necessary. You can make the grid as big or small as you'd like, 10 square yards or 10 square feet. However, the bigger the grid, the easier the students will be able to walk around in it.
- Place tape on the x and y axes at the intersections of string. Use one color tape for the x-axis and the other for the y-axis. Use the permanent marker to number the tape 0-10.
- Highlight the numbers of the x and y axes on the two paper, coordinate grids with the same colors as the tape of the life-size coordinate grid.
- Walk through the grid and record 3 garden objects for every pair of students on the 8 ½ x 11" master grid. (i.e. (1,7)beets; (3,8)stepping stone; (5,4)sunflower; etc.)
- Write each set of (x,y) coordinates on separate index cards. DO NOT write the objects to be found, that's for the children to complete during the lesson.
- Place the 5 objects (ex. unifix cubes) in well hidden areas in the garden but outside the grid. They should not be able to be seen as students casually walk through the garden.

Procedure

Engage! Hide and seek in the garden.

- Show students an example of what you have hidden.
- Let the students know the boundaries of the game and that the object is NOT hidden in the coordinate grid.
- Tell them their goal is to find the object you have hidden and that they will be timed 5 minutes.
- Have students go find the object. If they find it, let them know their time. If time runs out, have them come back together.

Question: Would it be easier to find an object if I gave you a hint of where it is? (YES!)

- Split the class into four groups, but have them stay with you until you say, “Go!”
- Give each group a hint/direction (i.e. look in the rocks under the apple tree).
- Let students know this round of the game they are challenged to find and bring back the object within **1** minute.

Question: What was the difference between the first round of the game and the second round in which I gave you a hint/direction. (Much easier/faster) Does anyone know what maps are for? (They are pictures that use symbols to represent an area.) Today we are going to use mapping skills to find “treasures” in our garden and create a map for others.

Activity: Walking the coordinate grid.

- Bring students to the coordinate grid.
- Show them the numbers of the x and y axes.
- Hold up an index card with a set of coordinates.
- Inform students mathematicians have agreed the x coordinate is written first, then the y.
- Have two students volunteer to “find” the garden treasure that is located at these coordinates.
- Have the first student walk to the corresponding number on the x-axis. (The rest of the class can be counting the numbers as the student walks by.)
- Have the second student walk to the corresponding number on the y-axis. (The rest of the class can be counting the numbers as the student walks by.)
- Have the two students turn into the grid and follow their strings until they meet.
- One student should write or draw what they found on the index card, the other should write/draw on the coordinate grid poster.
- Continue until each pair has had 2 turns.

Let's Review

- Look at the coordinate grid map that the students completed and the garden. Talk about their similarities and differences.

Keep Exploring

- Students add other favorite parts of the garden to the poster of the garden coordinate grid.
- Try a scenario in which two students walk the grid to coordinates (1,9) and another two walk to (9,1) to demonstrate the importance of knowing the x coordinate is written first.

32. Aha! We Found It! – K

Name _____ Date _____

Draw your favorite part of the garden that is in the coordinate grid:

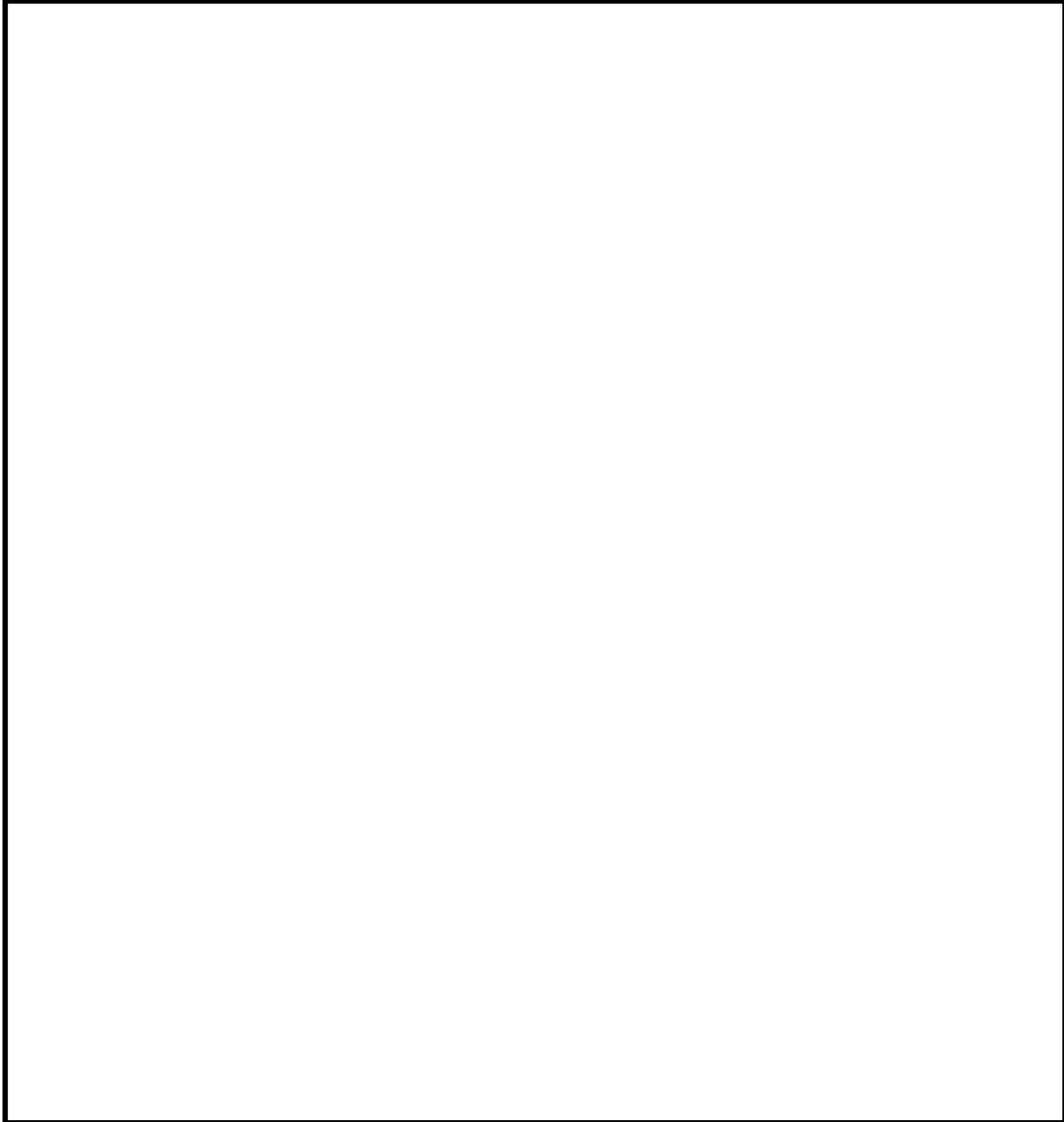

1. What is the x coordinate? _____

2. What is the y coordinate? _____

Our Garden Coordinate Grid

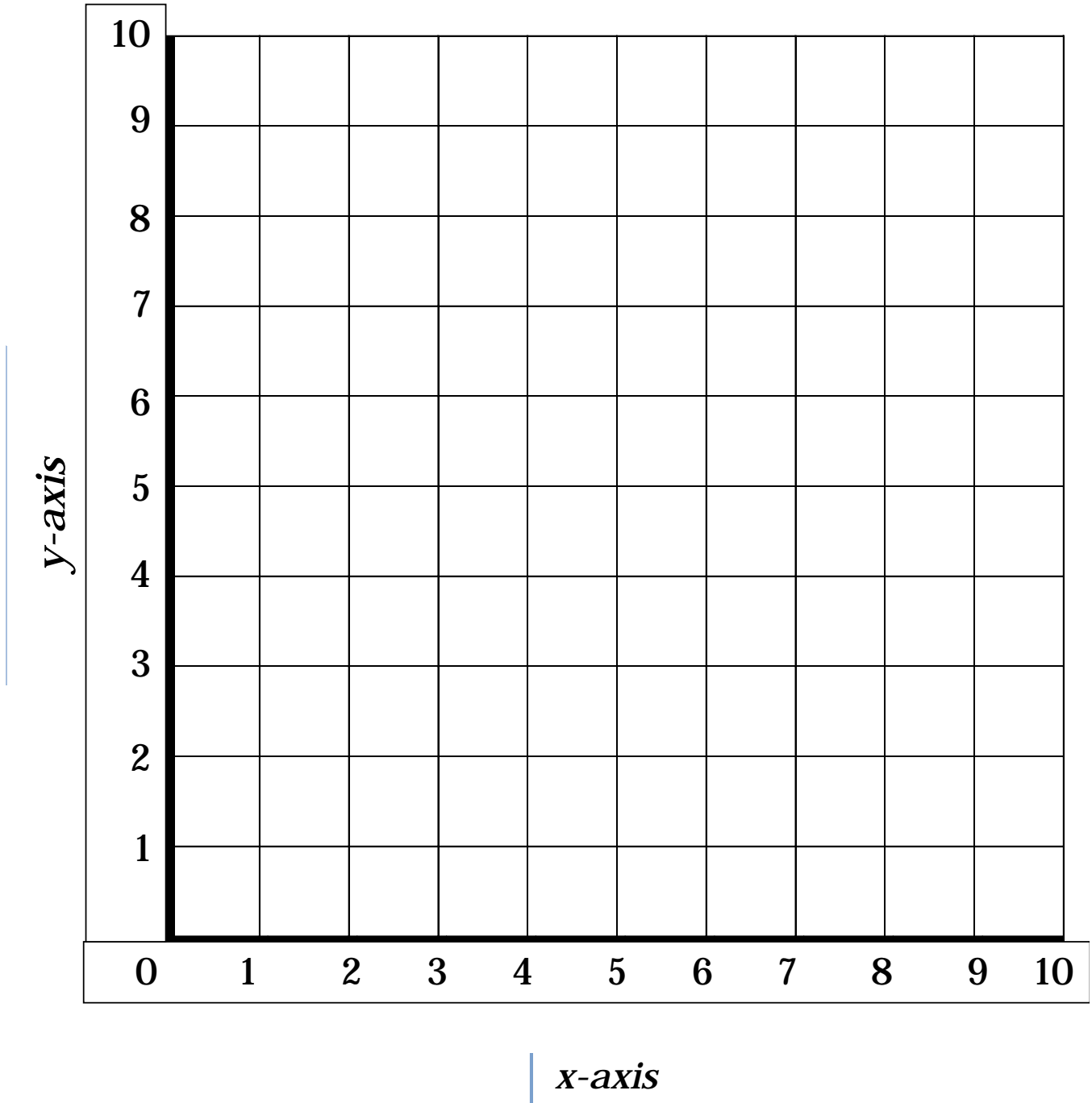

33. Let's Eat!

Our End of the Year Party

Objective: Students harvest from the school garden, prepare a dish to share, and complete the end-of-season evaluation.

- Observe change happens to many things.
- Adopt basic safety with food preparation and knife safety.
- Apply proper care of the body by eating a variety of foods.

Materials

- Digging fork
- Large bucket
- Trowels
- Large bowl
- Cutting boards
- Knives
- Large saucepan
- Medium saucepan
- Stove
- 2 cups half and half
- 6 Oz. parmesan
- 2 tablespoons salt
- Additional salt and pepper to taste
- Bowls (1 per student)
- Forks (1 per student)
- Post-season evaluations (1 per student)



Preparation

- Check if there are new potatoes ready for harvest. If not, supplement with store potatoes and let the school garden potatoes grow a little longer.
- Print post-season evaluations.

Procedure

Engage! *It's the end of the school year, let's harvest our new potatoes!*

- Go to the potato plants in the garden.
- Let students know that new potatoes, baby potatoes, are only 1" – 1 ½" in diameter.
- New potatoes are ready to harvest about a week after the flowers have bloomed.
- Have students look at the plants and for signs of old flowers.

- Next students should take turns digging alongside the trench potato plants rather than in the trench so as to avoid stabbing any tubers. Also have students dig as carefully as possible around the potato plants in the compacted soil.
- Once students have loosened the soil, DIG IN! They should use their hands to try to find as many little potatoes as possible.
- Have the large bucket available for students to put their harvest in.
- While students are digging for potatoes, have them observe similarities and differences between the potatoes grown in the loose trenches as compared to the potatoes in the compacted soil.

Activity: Harvest spring garlic.

- Show students how to use trowels to dig up garlic. They should dig away from the stem of the plant so as not to stab the bulb of garlic.
- This is spring garlic so the “paper” covering will be soft instead of dry. It’s ok to leave soil on the bulb itself, but try to get the majority of soil off the roots.
- Garlic is usually harvested mid-June to mid-July in Salt Lake City, depending on the weather that year. If your school has a summer school program, you may want to leave some in the ground. If students will be absent through the summer, they may want to harvest all the garlic so that some can be used in today’s lesson and the rest can be sent home.
- *Green garlic leaves can also be used when cooking! They don’t store well like the mature bulbs, so use them while they are fresh.

Activity: Make garlic mashers. (Recipe adapted from Alton Brown at www.foodnetwork.com)

- Wash and halve the new potatoes.
- Place the potatoes (recipe calls for 3 ½ pounds) in a large saucepan, add the salt, and cover with water. Bring to a boil over medium-high heat and then reduce heat to maintain a rolling boil. Cook until potatoes fall apart when poked with a fork.
- Meanwhile, heat the half-and-half and the garlic in a medium saucepan over medium heat until simmering. Remove from heat and set aside.
- Remove the potatoes from the heat and drain off the water.
- Mash and add the garlic-cream mixture and Parmesan; stir to combine.
- Let stand for 5 minutes so that mixture thickens and then serve.

Activity: Post-season evaluation.

- While potatoes are thickening, have each student complete the post-season evaluation.

Let’s Review

- Serve the garlic mashers.
- Ask about the students’ favorite part of the gardening season this school year.

33. I Know a lot About Plants!- K

Name _____ Date _____

Draw and color 2 kinds of plants:

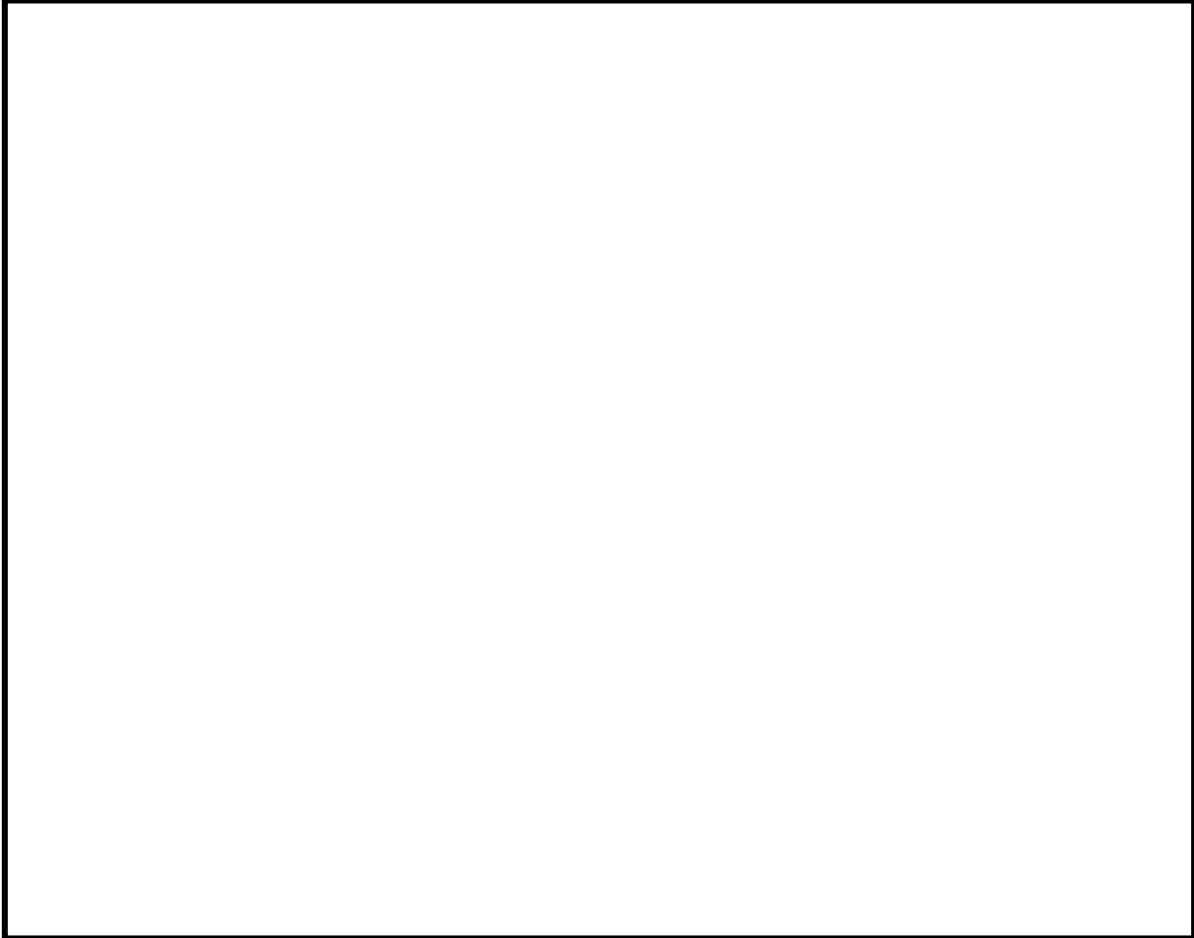

What is your favorite part about garden classes? _____

What was the most interesting thing you learned? _____

Curriculum Connections

Garden and plant based classes connect to a wide variety of state and national curriculum areas. The most obvious one is science, but also covered are many standards of literacy, math, social studies, and art. Included is a chart showing the direct connections between the WCG garden classes and the relevant Utah state standards of science. These follow the new (2011) national core curriculum standards.

The other curricula areas are not charted here, but are implicit in the lessons. For example, in regards to Language Arts, students develop language through listening, speaking, and through viewing a variety of media presentations. As they learn new vocabulary words by listening, reading, and discussing a variety of genres, they also practice using context to determine and explain meanings of unknown key words. They keep an ongoing garden lesson journal in which they write and/or draw every week, and often give presentations of their findings to their classmates.

Math is threaded throughout many of the lessons as well. Students measure, collect and organize data in a variety of ways, and problem solve using basic algorithms. Students use math in real, hands-on life experiences: measuring space to plant, using recipes, graphing soil organisms found, charting coordinates of garden treasures, planning a budget for a shopping trip, and more.

In addition, students learn about their place in their community and family, nutrition facts, research techniques, and more. As mentioned in the introduction, many of the lesson objectives are based on the Salt Lake City School District Curriculum Standards 2011. A great source of information, from the U.S. Botanic Garden and the Chicago Botanic Garden, about connecting plant-based education with the national standards can be found at <http://www.schoolgardenwizard.org/> under the heading “Make The Case”. More ideas about how to strengthen and enhance your classes in the garden are under the heading “Learn In The Garden”.

K: Science Curriculum-Part Two

	Stan.1	Obj. 1	Obj. 2	Obj. 3	Stan. 2	Obj. 1:	Obj. 2	Obj. 3	Stan.3	Obj. 2	Stan. 4	Obj. 1	Obj. 2
1. Growing In The Garden	X	X	X	X							X	X	
2. Help Me Out!	X	X	X	X							X	X	X
3. Do We Eat Plants?	X	X	X	X							X	X	X
4. It's Not Dirt, It's Soil!	X	X	X	X	X	X					X	X	
5. Creepy Crawlies	X	X	X	X							X	X	X
6. Six of One, Half Dozen of Another	X	X	X	X							X	X	X
7. Plants Are Friends Too!	X	X	X	X							X	X	X
8. A Pumpkin is a What?	X	X	X	X							X	X	X
9. It's Chilly Out Here!	X	X	X	X	X			X			X	X	X
10. The Worms Crawl In	X	X	X	X							X	X	X
11. Plant Use Detectives!	X	X	X	X							X	X	X
12. The Botanist's Hike	X	X	X	X							X	X	X
13. We All Work Together	X	X	X	X							X	X	X
14. More Plant Part Jobs!	X	X	X	X							X	X	X
15. Let's Build Our Plant Lab	X	X	X	X	X			X	X	X	X	X	X
16. Really, That's What We Need!	X	X	X	X							X	X	X
17. Yikes! It's Hot In Here	X	X	X	X							X	X	X
18. Plants From Parts?	X	X	X	X							X	X	X
19. From Garden To Tummy	X	X	X	X							X	X	X
20. Let's Go Shopping!	X	X	X	X							X	X	
21. Now It's Really Cold!	X	X	X	X	X			X			X	X	X
22. Wow! You Know A Lot!	X	X	X	X							X	X	X
23. Flower Power!	X	X	X	X							X	X	X
24. Eat A Rainbow	X	X	X	X							X	X	X
25. Plant a Cool Rainbow	X	X	X	X							X	X	X
26. Poetry In The Garden	X	X	X	X							X	X	X
27. Signs of Spring	X	X	X	X	X			X			X	X	X
28. Pound That Plant!	X	X	X	X	X	X					X	X	X
29. Let's Make Some Connections	X	X	X	X							X	X	X
30. Thank You Pollinators!	X	X	X	X							X	X	X
31. Hands Across the Garden	X	X	X	X							X	X	X
32. Aha! We Found It!	X	X	X	X							X	X	X
33. Let's Eat!	X	X	X	X							X	X	X

Kindergarten Curriculum Connection Part Two

Science

Standard 1: The Processes, Communication, and Nature of Science: Students will be able to apply scientific processes, communicate scientific ideas effectively, and understand the nature of science.

- Objective 1: Generating evidence: Using the processes of scientific investigation (i.e. framing questions, designing investigations, conducting investigations, collecting data, drawing conclusions)
- Objective 2: Communicating Science: Communicating effectively using science language and reasoning
- Objective 3: Knowing in Science: Understanding the nature of science

Standard 2: Earth and Space Science: Students will gain an understanding of Earth and Space Science through the study of earth materials, celestial movement, and weather.

- Objective 1: Investigate non-living things.
- Objective 2: Observe and describe changes in day and night.
- Objective 3: Compare the changes in weather over time.

Standard 3: Physical Science: Students will gain an understanding of Physical Science through the study of forces of motion and the properties of materials.

- Objective 2: Describe the parts of non-living things.

Standard 4: Life Science: Students will gain an understanding of Life Science through the study of changes in organisms over time and cell theory.

- Objective 1: Investigate living things.
- Objective 2: Describe the parts of living things.

Resources

The following list contains great resources for additional plant-based activities in and out of the classroom. We gained inspiration for some of the lessons in Wow! Plants Are So Cool! (Part 2) from several of these materials, and/or used the following resources in compiling the background information handouts.

Books:

Alameda County Waste Management Authority & Source Reduction and Recycling Board.
Do the Rot Thing: A Teacher's Guide to Compost Activities

Barrett, Katharine D. Botany on Your Plate

Gardner, Robert. Science Projects About Plants

Grant, Tim and Littlejohn, Gail, ed. Greening School Grounds-Creating Habitats for Learning

Hershey, David R. Plant Biology

Hunken, Jorie. Botany for All Ages

Jaffe, Roberta and Appel, Gary. The Growing Classroom

Kite, L. Patricia. Gardening Wizardry for Kids

Macleod, Elizabeth. Grow It Again

Moore, Jo Ellen. Learning About Plants

Moore, Jo Ellen. Plants

National Gardening Association. Grow Lab: A Complete Guide to Gardening in the Classroom

National Gardening Association. Grow Lab: Activities for Growing Minds

Perry, Phyllis J. Science Fair Success With Plants

Robert L. Bonnet and G. Daniel Keen. 49 Science Fair Projects: Botany

Texas Agricultural Extension Service. Junior Master Gardener Leader Guide

Van Cleave, Janice. Plants

White, Jennifer M., et.al. Math in the Classroom

Websites:

Butterflies and Moths of North America: www.butterfliesandmoths.org

California Foundation for Agriculture in the Classroom: www.cfaitc.org

Food Network: www.foodnetwork.com

Governor of California: www.firstlady.ca.gov

National Gardening Association-KidsGardening: www.kidsgardening.org

North Carolina State Department of Agricultural: www.cals.ncsu.edu

Red Butte Garden: www.redbuttegarden.org

Resources on Pollinators: dels-old.nas.edu/pollinators/aboutpollinators.shtml

Southern Living Cooking School: www.myrecipes.com/recipe/garlic-spinach-dip

Tom Clothier's Garden Walk and Talk: tomclothier.hort.net

U.S. Department of Agriculture: www.choosemyplate.gov

Utah Agriculture in the Classroom: www.utah.agclassroom.org

Utah School and Youth Garden Network: utahgardennetwork.org

Utah State University Extension: extension.usu.edu

Wasatch Community Gardens: www.wasatchgardens.org

Additional Gardening Resources in Salt Lake City

Nurseries

Glover Nursery
9275 S. 1300 West, West Jordan
(801) 562-5496

Grow Wild Nursery (great source for native plants-open seasonally)
372 East 2100 South
Salt Lake City, UT
(801) 363-3249, (801) 467-8660

Growing Empire Landscaping (perennial plants)
820 East Empire Ave. 3530 South (off of 700 South on Empire), Salt Lake City
(801) 685-7099

Millcreek Gardens
3500 S 900 East, Salt Lake City
(801) 487-4131

Traces-source for organic starts
1432 S 1100 East, Salt Lake City
(801) 467-9544

Wasatch Shadows
9295 S. 255 West, Sandy
(801) 566-0608

Western Garden Center
550 S 600 East, Salt Lake City
(801) 364-7871
4050 W 4100 South, West Valley City
(801) 968-4711

Soil, compost

Twin Pines Nursery
8200 S 700 East, Sandy
(801) 255-0711

Replenish Landscape Garden Products
4660 South 200 West
Murray, UT
(801) 262-5142
www.replenishcompost.com

Wasatch Shadows
Millcreek Gardens
IFA Country Stores

Planting, fertilizer, seeds, straw, and other gardening and farming supplies

AA Callister
3615 South Redwood Rd.
West Valley City, UT
(801) 973-7058

IFA Country Stores
1147 W 2100 South, Salt Lake City
(801) 972-3009
1926 W 12600 South, Riverton
(801) 254-3501

Steve Regan Co.
4215 S 500 West, Salt Lake City
(801) 268-4500

Waterwise Information

Utah's Choice Plants- www.utahschoice.org
Slow the Flow Program- www.slowtheflow.org, 877-SAVE-H2O
Waterwise Plants- www.waterwiseplants.utah.gov
Conservation Garden Park at Jordan Valley- www.conservationgardenpark.org

Watering System Supplies

England Plumbing
1009 East 3300 South, SLC
801-485-3371

Sprinkler World
8451 South Sandy Parkway, Sandy
801-562-4578

Tools and Gardening Supplies Online:

Amazon- www.amazon.com
Charley's Greenhouse- www.charleysgreenhouse.com
Corona Tools- <http://www.coronaclipper.com/>, 800-847-7863
Fiskars- www.fiskars.com
Fist Grip Tools-various web sites
Gardeners Supply- www.gardeners.com
Gardens Alive- www.gardensalive.com
Gardenscape- www.gardenscape.on.ca/
OXO International- www.oxo.com
Peaceful Valley Farm & Garden Supply- www.groworganic.com
Peta Easi-Grip- www.peta-uk.com/usashop/acatalog/In_the_Garden.html
Planet Natural- www.planetnatural.com
Radius Tools- www.radiusgarden.com

Accessible Gardening Websites:

American Horticultural Therapy Association- www.ahta.org
Gardening for Good- www.gardening4good.org
Chicago Botanic Garden- www.chicagobotanic.org
Garden Forever- www.gardenforever.com
Gardening With Ease- www.gardeningwithease.com
Life With Ease- www.lifewithease.com

Raised Beds

Information from Texas A&M-<http://aggiehorticulture.tamu.edu/extension/raisedbed/>
Gardeners Supply- www.gardeners.com
Earth Easy- www.eartheasy.com
Raised Bed Gardening Tips- www.raisedbedgardeningtips.com

Vegetable Fact Sheets from USU (Great resource for local growing)
<http://extension.usu.edu/yardandgarden/htm/vegetables-fruits-herbs>

Soil Testing

USU soil testing- www.usual.usu.edu

Seeds and Plants Online

Heirloom Seeds-P.O. box 245, W. Elizabeth, PA, 15088-0245
High Altitude Gardens- seedsave.org (site for other information too)
High Country Gardens- www.highcountrygardens.com
Park Seed Co.-www.parkseed.com (seed tapes)
Rene's Garden Seeds- www.reneesgarden.com
Seeds of Change- www.seedsofchange.com
Select Seeds- www.selectseeds.com
Territorial Seeds- www.territorial-seed.com
Totally Tomatoes- www.totallytomato.com
Vermont Bean Seed Company- www.vermontbean.com
Wood Prairie Farm- www.woodprairie.com (organic seed potatoes)

Compost from landfills (use with caution on edible plants)

Central Valley Water Reclamation Facility- www.cvwrfl.org
Salt Lake County Landfill- www.slvlandfill.slco.org

Worms and castings

Rott'n Apple Worm Farm- www.rottenapplewormfarm.com (he comes to our Farmer's Market)
I've Got Worms- www.gotworms.info (started by a 7 year old!)

Pest and disease diagnostic web sites

Utah Pests- <http://utahpests.usu.edu>
Weed Seedling Photos-
<http://www.extension.umn.edu/distribution/cropsystems/DC0776.html>
Weed ID- <http://weedid.missouri.edu/index.cfm>
Iowa State Insects- <http://www.ent.iastate.edu/imagegallery/>

Site with various pest ID links-

<http://entweb.clemson.edu/pesticid/saftyed/pstident.htm>

Plant disease site- <http://www.extension.umn.edu/gardeninfo/diagnostics/index.html>

Vegetable MD online (Cornell University)- <http://vegetablemdonline.ppath.cornell.edu/>

There are many more-explore!

Salt Lake Master Gardeners-www.slmg.org

Call about plant diagnostic clinics starting on Mondays in June and the MG help desk (801) 468-3172

Other Useful Websites

Horticulture Magazine- www.hortmag.com

Organic Gardening Magazine- www.organicgardening.com

Utah Native Plant Society- www.unps.org

Utah State University Extension- www.extension.usu.edu

National Gardening Association- www.garden.org

American Horticultural Society- www.ahs.org

Books

Botany For Gardeners-Brian Capon

A Book of Bees-Sue Hubbell

Carrots Love Tomatoes:Secrets of Companion Planting for Successful Gardening-Louise Riotte

Enabling Garden-Gene Rothert, HTR

Garden Insects of North America-Whitney Cranshaw

Gardening With Good Bugs-Erin W. Hodgson

Green Nature/Human Nature-Charles A. Lewis

How to Grow More Vegetables-John Jeavons

Insect, Disease & Weed I.D. Guide-J. Jesiolowski Cebenko & D. Martin, editors

Joy of Gardening-Dick Raymond

Just The Facts! Dozens of Garden Charts-Editors of Garden Way Publishing

Lasagna Gardening-Patricia Lanza

Natural Enemies Handbook-Mary Louise Flint and Steve H. Dreistadt

Plant Propagation-American Horticultural Society

Planters, Containers, and Raised Beds-Chuck & Barbara Crandall

Rodale's All-New Encyclopedia of Organic Gardening-Fern Marshall Bradley and Barbara W. Ellis, editors

Rodale's Illustrated Encyclopedia of Gardening and Landscaping Techniques-Barbara Ellis, editor

Roots, Boots, Buckets, and Shoots-Sharon Lovejoy (gardening with children)

Square Foot Gardening-Mel Bartholomew

Teaming with Microbes-A Gardener's Guide to the Soil Food Web-Lowenfels and Lewis

The Able Gardener: Overcoming Barriers of Age and Physical Limitations-Kathleen Yeomans

The Garden Problem Solver-The Reader's Digest Association

The Organic Garden-Christine and Michael Lavelle

The Organic Gardener's Handbook of Natural Insect and Disease Control-B. W. Ellis and F.M. Bradley, editors

The Organic Gardeners Handbook-Frank Tozer
The Ortho Home Gardener's Problem Solver-Cheryl Smith, editor
The Truth About Garden Remedies-Jeff Gillman
The Truth About Organic Gardening-Jeff Gillman
The Vegetable Growers Handbook-Frank Tozer
Trellises and Arbors-Editors of Sunset Magazine
Weeds of the West-Tom D. Whitson, editor
Western Garden Book-Sunset Publishing
Western Garden Problem Solver-Sunset Publishing
What's Wrong With My Plant?-David Deardorff and Kathy Wadsworth
Worms Eat My Garbage-Mary Appelfhof